



People.Health.Care.

OR Set Systems

Your solution in the OR from L&R.



OR Drape System

OR Clothing

Single-use Instruments

OR Dressing Materials

OR Custom Procedure Tray

Table of Contents

Introduction to OR Set Systems	4	C-section Drape	32
Raucodrape OR Drape System		Baby Drape	32
General Information	6-14	C-section Set I	32
General Surgery		C-section Set	33
Basic Set Mini	16	C-section Set II	33
Basic Set	16	Gynaecology/Cystoscopy Set	34
Basic Set I	16	Cystoscopy Set	34
Basic Set II	17	Gynaecology/Cystoscopy Drape	34
Basic Set Super	17	Lithotomy Set	35
Set for Minor Procedures	18	Gynaecology Set I	36
Set for Minor Procedures I	18	Gynaecology/Urology Set	36
Set for Minor Procedures II	18	Gynaecology Set II	36
Universal Set	19	T.U.R. Set I	37
Universal Set I	19	T.U.R. Set	37
Universal Set I Super	20	T.U.R. Set II	37
Universal Set II	20	Orthopaedics/Traumatology	
Basic Split Sheet Set	21	Universal Split Sheet Set I	39
Universal Split Sheet Set I	21	Orthopaedics Set	40
Universal Split Sheet Set	22	Hip Set I	40
Universal Split Sheet Set II	22	Hip Set II	41
Variable Split Sheet Set	23	Hip Set III	41
LAP Set I	24	Hip Arthroscopy Set	42
LAP Set II	24	Extremity Set I	43
LAP Set III	24	Extremity Set II	43
Rectum Set I	25	Extremity Set	43
Abdominal/Perineal Set	25	Extremity Set III	44
Rectum Set II	25	Extremity Set Hand/Foot	44
Paediatrics		Hand Surgery Set	45
Paediatric Basic Set	27	Extremity Drapes	46
Fenestrated Drape with Surgical Incision Film	27	Extremity Drape, bilateral	46
Gynaecology/Urology		Extremity Drapes Hand/Foot	47
Pfannenstiel Set	29	Extremity Drape Hand/Foot	47
Rectum Set I	30	Arthroscopy Set I	48
Abdominal/Perineal Set	30	Arthroscopy Set II	48
Rectum Set II	30	Arthroscopy Set	48
Delivery Set I	31	Arthroscopy Set III	49
Delivery Set II	31	Arthroscopy Set IV	49
		Shoulder Arthroscopy Set I	49

Knee Arthroscopy Set	50	Equipment Covers	71
Knee Arthroscopy Drape	50	Equipment Cover	71
Shoulder Arthroscopy Set, Beach Chair	51	Accessories	72
Vertical Drape Set	52	Foot protectors, transparent	72
Vertical Drape	52	Baby Drape	72
Neurosurgery, ENT, CMF, Ophthalmology		Accessories	73
Cranio Set	54	Surgical Incise Drape	74
LAP/Spinal Drape	54	OR Clothing	
Head Set I	55	Scrub Suits	76-78
Head Set II	55	Surgical Gowns	79-83
Variable Split Sheet Set	56	Surgical Face Masks	84-85
Split Sheets	56	Surgical Caps	86-87
Fenestrated Ear Drape	57	Surgical Gloves made from natural rubber latex	88
CMF Drape	57	Examination Gloves made from natural rubber latex	88
Eye Drape	58	Examination Gloves made from nitrile	89
Cardiovascular Surgery/Angiography		Sentina® Azure Nitrile	89
Cardiovascular Set	61	Cotton Gloves	90
Hybrid Set	61	Visitor Gowns	90
Angiography Drape I	62	Setpack OR Dressing Materials	
Angiography Drape II	62	General	91
Angiography Drape III	62	Laparotomy Swabs, X-ray detectable	93
Drapes and Accessories		Gauze Swabs, X-ray detectable	94
Drape Sheets	64	Gauze Balls, X-ray detectable	95
OR Drape Sheets	64	Dissecting Swabs, X-ray detectable	96
OR Table Covers	65	Individual Sets	97
OR Adhesive Drapes	66	Kitpack OR Custom Procedure Trays	
Fenestrated Drapes	67	General	98-100
OR Fenestrated Drapes	67-68	Kitpack start	101-103
Interventional Puncture Drape	67	Raucocel Accessories	104-105
Epidural Drape	68	L&R OPTILINE®	106-107
CMF Drape	68		
Fenestrated Ear Drape	69		
Fenestrated Drape with Surgical Incision Film	69		
LAP/Spinal Drape	69		
OR Split Sheets	70		
OR Split Sheet	70		
Split Sheet	70		

OR Safety

Our comprehensive surgical solutions offer you a complete surgical range that meets very high standards. For all of our products – Raucodrape OR drapes, Sentinex OR clothing, Setpack OR dressing material sets or Kitpack OR custom procedure trays made up individually for you: Quality and functionality are the focus of our products, which is how we guarantee greater reliability and efficiency in your OR.

Protection and safety

Prevention of intra- and postoperative infections during surgery is the top priority. This means that products and materials used during surgery must meet stringent requirements. Patients and staff can only be reliably protected if all pathogen transmission routes are cut off to the extent possible. OR products from L&R play an essential role in helping to do this.

The sterile Raucodrape OR drape system by L&R meets and in many cases exceeds the requirements stipulated by the European EN 13795 series of standards. These standards define the basic requirements for OR drapes and gowns. The standards specify minimum values for resistance against fluid and pathogen penetration, among other requirements. In addition to the European Standard EN 13795, a large part of the range complies with the AAMI standard of the American National Standards Institute (ANSI). Raucodrape provides a complete barrier against infection and is an important part of effective infection prophylaxis in the OR. Together with Sentinex OR clothing, Kitpack OR custom procedure trays and Setpack OR dressing materials, L&R provides a full range of products for all surgical procedures.

Cost-effectiveness and expertise

Our medical device consultants, who have many years of practical experience, analyse your work flows and processes together with you and develop tailored, cost effective solutions.

Monitoring and quality

All our products are precisely adjusted to the customer's particular requirements in terms of material and function and are subject to ongoing stringent quality inspections. We place great value on safety standards which, in some cases, even exceed the legal requirements.





- | | |
|--|-------------------------------------|
| ① Sentinex® Surgical Face Masks | ⑧ Setpack® OR Dressing Materials |
| ② Sentinex® Scrub Shirts | ⑨ Kitpack® OR Custom Procedure Tray |
| ③ Sempermed® Surgical Gloves* | ⑩ Sentinex® Thermo jacket |
| ④ Kitpack® OR Custom Procedure Tray | ⑪ Sentinex® Surgical Gowns |
| ⑤ Sentinex® Scrub Pants | ⑫ Raucodrape® Surgical Incise Drape |
| ⑥ Sentinex® Surgical Caps | ⑬ Raucodrape® OR Drape |
| ⑦ Sentina® and Sempercare® Examination Gloves* | |

* Not available in all countries

Raucodrape® OR Drape System



Raucodrape®

Safety and comfort for the OR team and for patients

Raucodrape®

- offers a large range of sets and individual products
- optimises workflows in the OR, reduces procedure costs
- Natural rubber latex is not an ingredient in the production of Raucodrape OR Drapes.*
- The special combination of layers of absorbent PP** nonwoven fabric and impermeable PE** film ensures that the entire drape is absorbent and impermeable to fluids, thus creating a secure barrier against fluids and bacteria.

L&R offers a wide range of different materials and uses the following names for the range of OR drapes:

Raucodrape® PRO

- 2-layered (without reinforcement)
- 2-layered Plus (with reinforcement)
- 3-layered (without reinforcement)
- 3-layered Plus (with reinforcement)
- Single-layered (film: transparent or opaque)

Raucodrape® SMART

- 2-layered (without reinforcement)
- 2-layered Plus (with reinforcement)
- Single-layered (film: transparent or opaque)

Raucodrape® Drape Sheets

- 2-layered (without reinforcement)
- Single-layered (fluid-repellent nonwoven material)



* However, to the best of our knowledge we can't completely exclude any potential contaminations with latex traces from the production or the environment.

** PE: polyethylene, PP: polypropylene

Raucodrape® PRO OR Drape System

PRO – maximum protection for longer, more complicated procedures

- wide range of products
- premium, generous design with very high user comfort
- exceeds EN 13795 requirements
- a large part of the range fulfills the AAMI Standard

Raucodrape PRO OR Drape 2-layered

- for procedures with low to moderate amounts of fluid
- safe barrier effect against penetration by fluids and bacteria
- fully absorbent and impermeable to fluids
- high tensile strength
- very low linting

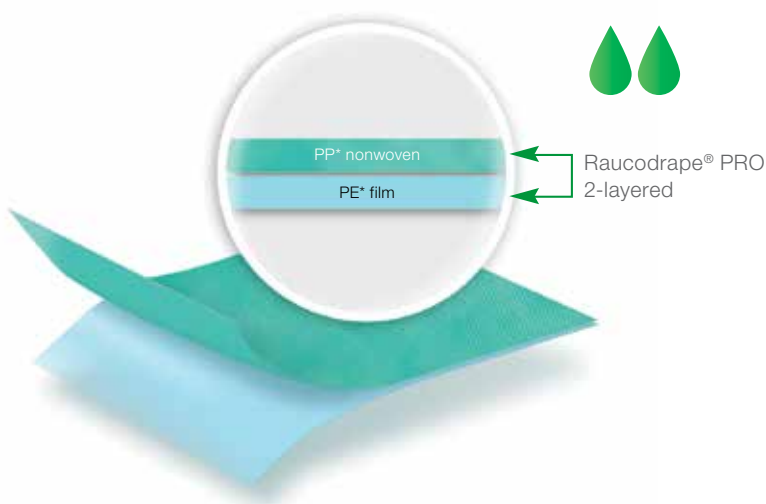

Raucodrape PRO OR Drape 2-layered Plus

- a plus for procedures with very high amounts of fluid
- safe barrier effect against penetration by fluids and bacteria
- very good absorbency and rate of absorption
- high tensile strength
- very low linting

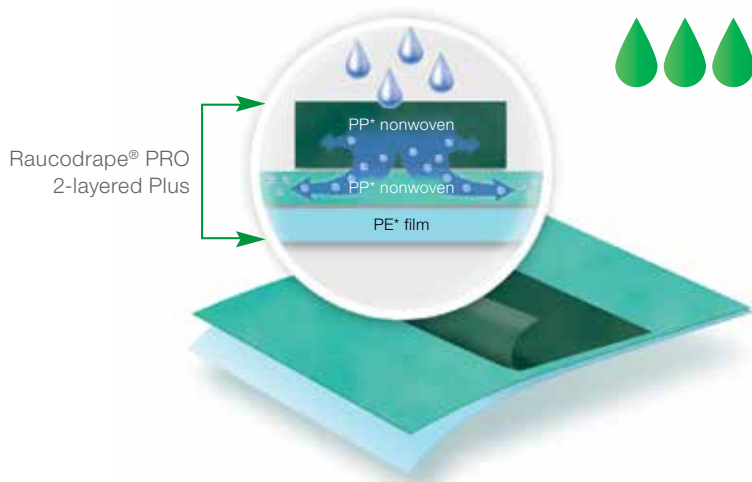

* PE: polyethylene, PP: polypropylene

Raucodrape PRO OR Drape 3-layered

- the 3-layered OR Drape offers more comfort for the patient due to the additional nonwoven layer
- for procedures with moderate to high amounts of fluid
- safe barrier effect against penetration by fluids and bacteria
- fully absorbent and impermeable to fluids
- high tensile strength
- very low linting

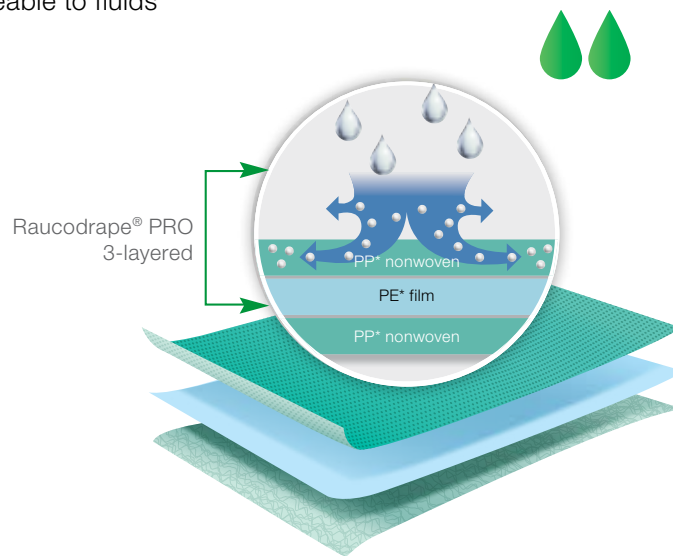

Raucodrape PRO OR Drape 3-layered Plus

- the 3-layered OR Drape offers more comfort for the patient due to the additional nonwoven layer
- a plus for procedures with very high amounts of fluid
- safe barrier effect against penetration by fluids and bacteria
- very good absorbency and rate of absorption
- high tensile strength
- very low linting

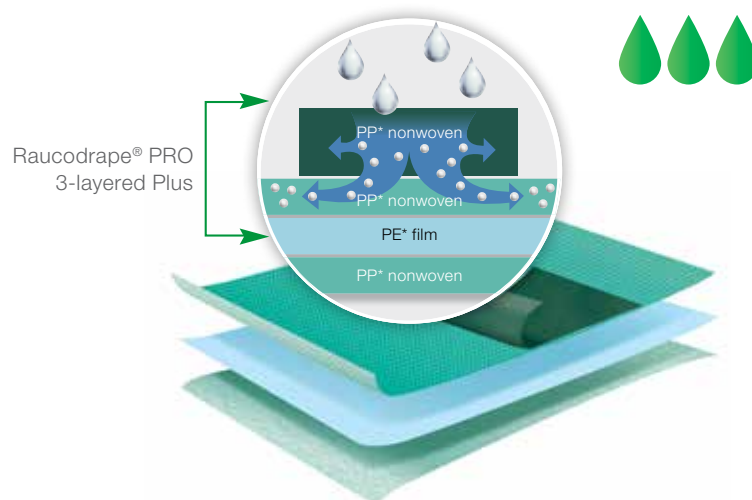

* PE: polyethylene, PP: polypropylene

Raucodrape® SMART OR Drape System

SMART – protection for shorter, less complicated procedures

- focused range of products
- functional design, very user-friendly
- meets the requirements of EN 13795 and the AAMI standard

Raucodrape SMART OR Drape 2-layered

- for procedures with small amounts of fluid
- safe barrier effect against penetration by fluids and bacteria
- fully absorbent and impermeable to fluids
- high tensile strength
- very low linting

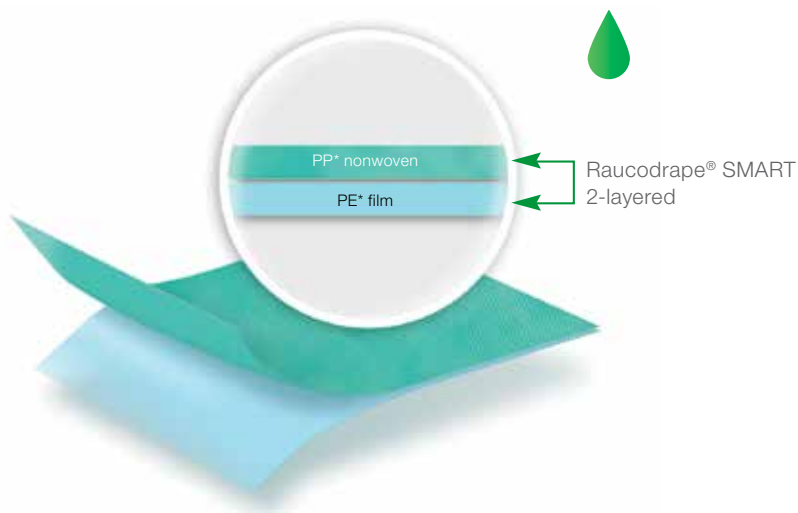

Raucodrape SMART OR Drape 2-layered Plus

- for procedures with moderate to high amounts of fluid
- safe barrier effect against penetration by fluids and bacteria
- very good absorbency and rate of absorption
- high tensile strength
- very low linting

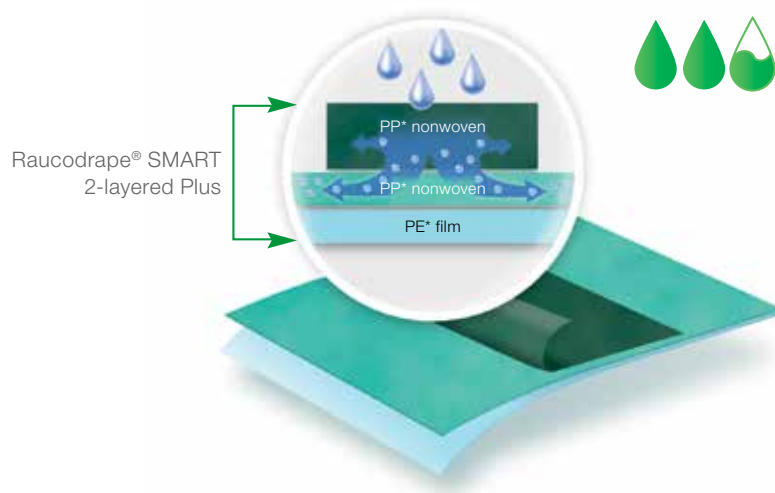

Raucodrape®

Strong solutions to the last detail

With Raucodrape®, unfolding is faster and easier

Raucodrape OR drapes are folded in a user-friendly manner. Each type of drape is folded in a particular way depending on its use to ensure that it can be used safely and is easier and quicker to unfold. On all self-adhesive fenestrated drapes, the fenestration is visible even before the drape is unfolded. This makes its correct application on patients much easier.

Clear pictograms

The readily understandable pictograms also ensure that the drapes can be unfolded safely and rapidly. They show at a glance, for example, the direction in which they should be unfolded, how to start unfolding them, how they should be positioned on patients, any slits, integrated leggings and more besides.

Three-piece adhesive strips

All split sheets have an ergonomically designed, three-piece adhesive strip for even easier application. Many adhesive drapes have a longer adhesive strip for adipose patients.

All adhesive strips are equipped with a 2-cm-long finger-lift for a quicker and safer grip.

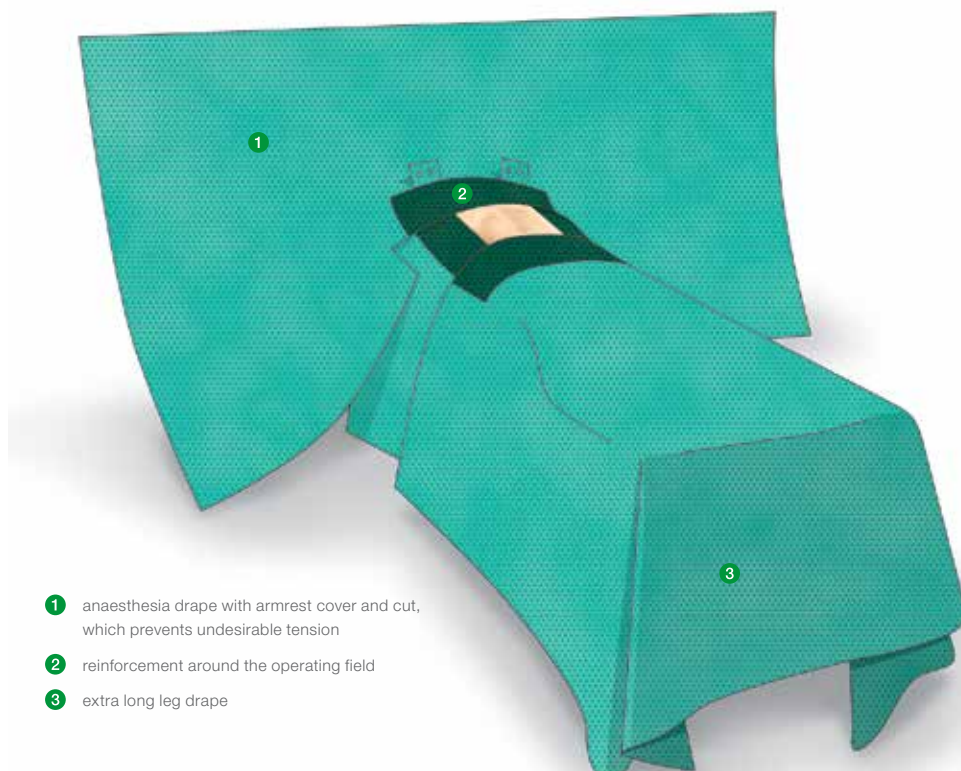

Raucodrape®

Pictograms



Indicates the positioning of the drape (cranially/caudally)

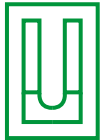

Indicates the direction of the slit

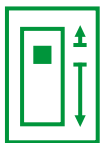

Indicates the off-centre fenestration



Indicates the position of the fluid collection pouch



Indicates the positioning of the integrated leggings (in the lithotomy position)



Indicates the centre of the adhesive drape (visible after first fold is opened out)



Indicates the positioning of the hands when applying the under buttocks drape and turban drape



Indicates the direction in which to unfold the leg protectors

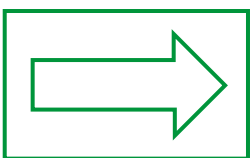

Indicates the direction in which to unfold all-in-one drapes

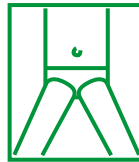

Indicates the perineal draping of the bilateral split sheet



Indicates the body and leg drape



Indicates the standard anaesthesia drape



Indicates the anaesthesia drape with armrest cover



Indicates the anaesthesia drape of the split sheet set

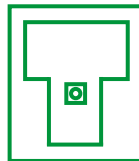

Indicates the positioning of the hand surgery drape

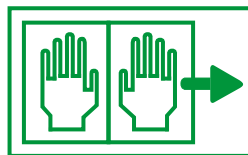

Indicates first unfolding step when opening up a set. Indicates the positioning of the hands when applying the instrument table cover

Raucodrape®

A sophisticated packaging concept for greater transparency and safety

Solid protection and reliable handling

A sophisticated modular packaging system ensures the requisite safety – during transport and storage and right up until it is used in the OR. The functional packaging with universally uniform and clear labelling of contents and EAN 128 barcodes for all packaging levels simplifies logistics control and safe handling of the products.

Heavy-duty transport and storage cartons

The transport and storage cartons made from recyclable materials reliably protect against damage.

Practical dispenser packaging

All individual products in the PRO range are packaged in a reclosable folding box with a dispenser opening. They ensure efficient storage and fast access to the sterile, individually packed products. Raucodrape sets are packaged in PE bags.



Peelable packaging in all formats

Raucodrape OR drapes are packaged in user-friendly peel pouches. They can be opened with a single action and simplify the fast and safe removal of sterile products.

All the important information at a single glance

The labelling of all products is clear and unambiguous. For both the visual depiction and textual description of the contents and the provision of all other required information, the same is always true: All information is legible and easy to understand.

Two identical documentation labels

Each peel pouch comes with a double set of self-adhesive documentation labels for fast and reliable documentation on OR reports.

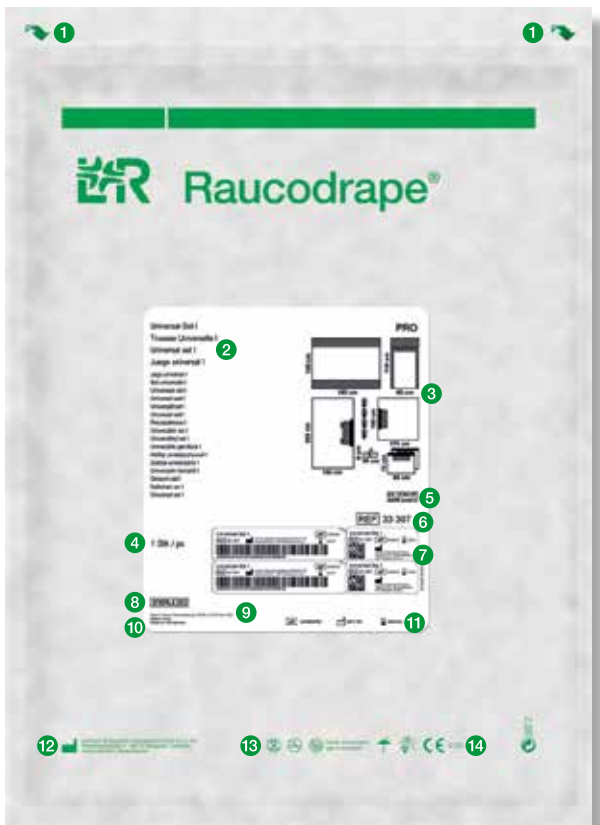

- 1 indication of the direction in which to peel open
- 2 product name in different languages
- 3 pictogram, product dimensions
- 4 quantity
- 5 EN 13795 marking / AAMI Level 4 marking
- 6 item number
- 7 self-adhesive documentation labels with EAN 128 barcode and data matrix code
- 8 "STERILE" symbol, incl. sterilisation method
- 9 indication of flammability class
- 10 "Made in" statement
- 11 lot number, date of manufacture, expiry date
- 12 manufacturer
- 13 safety symbols
- 14 CE marking

Raucodrape OR Drape System
Colour key
Materials and product details

The following pages show drawings of our OR drape sheets. Different colours and symbols represent the materials used and indicate special features of the respective OR drape.

In each case, the drawings show the view of the side away from the patient. To provide more complete information, the adhesive strips on the patient side are shown as red lines. This will give you a good overview of materials used and the special features of each drape.

-  Raucodrape PRO 2-layered
Raucodrape PRO 3-layered
-  Raucodrape PRO 2-layered Plus
Raucodrape PRO 3-layered Plus
-  Raucodrape SMART 2-layered
-  Raucodrape SMART 2-layered Plus
-  Wrapping paper
-  Drape sheet
-  Surgical incision film
-  Elastic adhesive film
-  Elastic cuff
-  PE film, transparent
-  PE film, turquoise
-  Towels
-  Nonwoven fabric layer instrument table cover,
nonwoven fabric layer OR table cover
-  Adhesive strip
-  Fluid-absorbent nonwoven material
-  Sieve insert
-  Hook-and-loop fastener
-  Reinforcing wire

General Surgery



Raucodrape® Basic Sets

General Surgery

Raucodrape® PRO Basic Set Mini

sterile

Contents	Size (cm)	REF	Shipping units (Pieces)
1 table cover	150 x 190	33 300	10/20
4 adhesive drapes, 2-layered	75 x 90		

Four-sheet drape for minor surgical procedures.

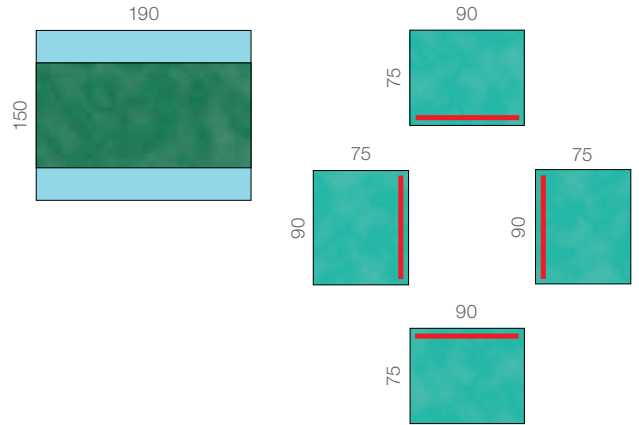

Raucodrape® SMART Basic Set

sterile

Contents	Size (cm)	REF	Shipping units (Pieces)
1 table cover	150 x 190	33 902	22
1 adhesive strip	9 x 25		
4 adhesive drapes, 2-layered	75 x 75		

Four-sheet drape for minor surgical procedures.

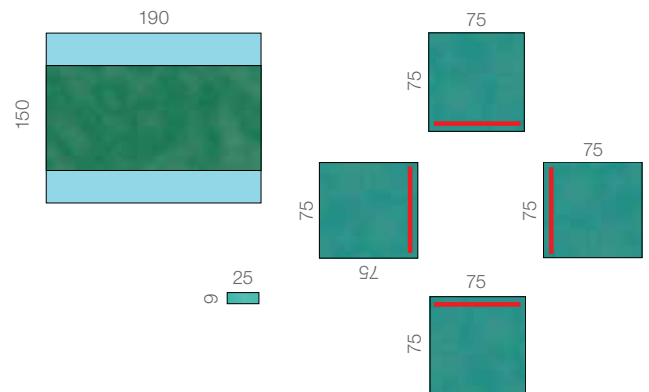

Raucodrape® PRO Basic Set I

sterile

Contents	Size (cm)	REF	Shipping units (Pieces)
1 table cover	150 x 190	33 301	13
2 towels	30 x 40		
1 instrument table cover	80 x 145		
2 adhesive drapes, 2-layered	75 x 90		
1 adhesive drape, 2-layered, adhesive strip (80 cm)	175 x 180		
1 adhesive drape, 2-layered, three-piece adhesive strip (15 + 70 + 15 cm)	150 x 240		

Four-sheet drape for interdisciplinary surgical procedures.

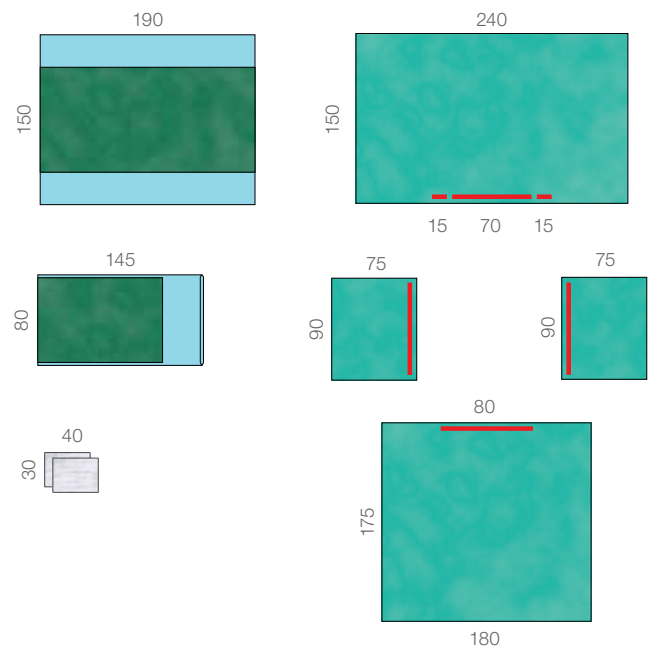

— indicates the side with the adhesive area

All measurements in cm

Raucodrape® PRO Basic Set II

steril

Contents	Size (cm)	REF	Shipping units (Pieces)
1 table cover	150 x 190	163 304	10
2 towels	30 x 40		
1 SMMS Surgical Gown Standard	130		
1 instrument table cover	80 x 145		
1 SMMS Surgical Gown Special	150		
1 adhesive strip	9 x 50		
1 diathermy pouch, 1 chamber	38 x 40		
2 adhesive drapes, 2-layered	75 x 90		
1 adhesive drape, 2-layered, adhesive strip (80 cm)	175 x 180		
1 adhesive drape, 2-layered, three-piece adhesive strip (15 + 70 + 15 cm)	150 x 240		

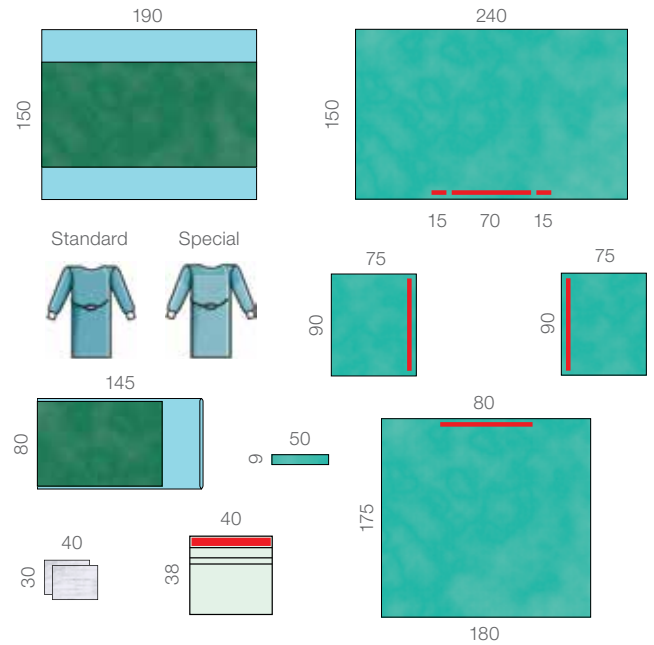

Raucodrape® PRO Basic Set Super

sterile

Contents	Size (cm)	REF	Shipping units (Pieces)
1 table cover	150 x 190	33 302	11
4 towels	30 x 40		
1 instrument table cover	80 x 145		
1 adhesive strip	9 x 50		
2 adhesive drapes, 2-layered	90 x 110		
1 adhesive drape, 2-layered, three-piece adhesive strip (15 + 70 + 15 cm)	190 x 225		
1 adhesive drape, 2-layered, three-piece adhesive strip (20 + 80 + 20 cm)	175 x 300		

Four-sheet drape with wide lateral drapes, long leg drape, and large anaesthesia drape for interdisciplinary surgical procedures.

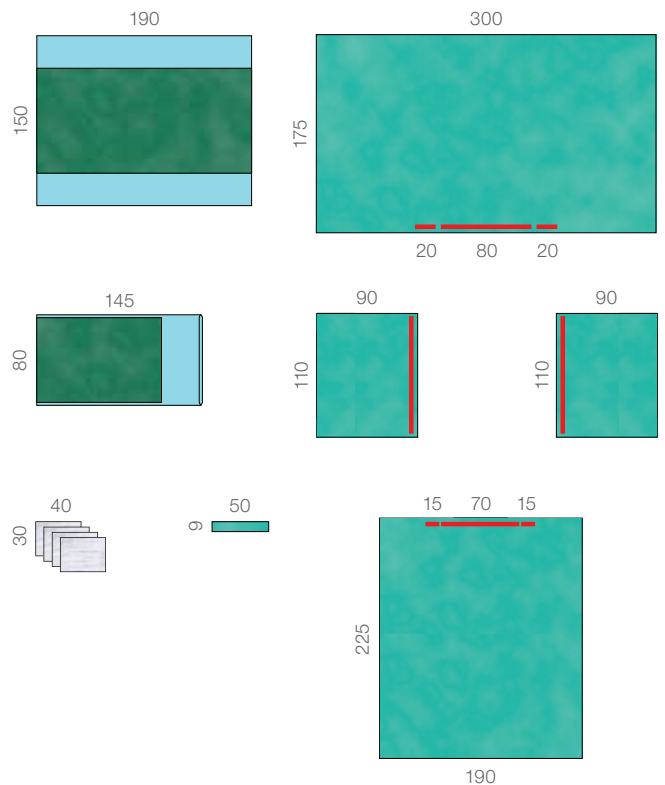

— indicates the side with the adhesive area

All measurements in cm

Raucodrape® Set for Minor Procedures General Surgery

Raucodrape® PRO Set for Minor Procedures

sterile

	Contents	Size (cm)	REF	Shipping units (Pieces)
1	table cover	150 x 190	33 315	22
2	towels	30 x 40		
1	adhesive strip	9 x 50		
1	fenestrated drape, 2-layered, self-adhesive, circular fenestration, centred	225 x 240		
		12		

All-in-one drape for minor surgical procedures.

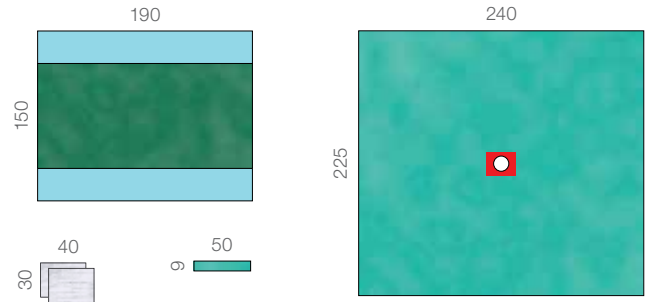

Raucodrape® SMART Set for Minor Procedures I

sterile

	Contents	Size (cm)	REF	Shipping units (Pieces)
1	table cover	150 x 190	34 915	18
1	adhesive strip	9 x 25		
1	fenestrated drape, 2-layered, self-adhesive, circular fenestration, centred	170 x 240		
		12		

All-in-one drape for minor surgical procedures.

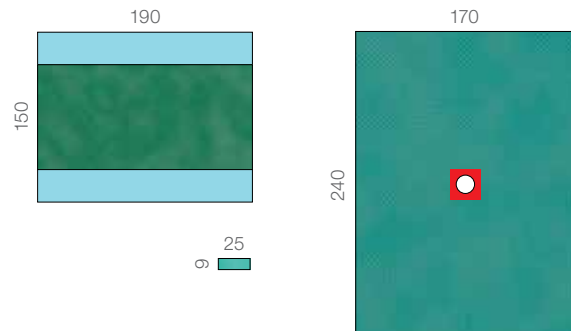

Raucodrape® SMART Set for Minor Procedures II

sterile

	Contents	Size (cm)	REF	Shipping units (Pieces)
1	table cover	150 x 190	34 916	18
1	adhesive strip	9 x 25		
1	fenestrated drape, 2-layered, self-adhesive, circular fenestration, off-centre	170 x 240		
		12		

All-in-one drape for minor surgical procedures.

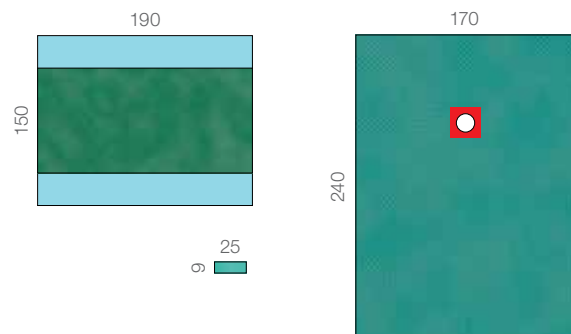

All measurements in cm

Raucodrape® Universal Sets

General Surgery

Raucodrape® SMART Universal Set

sterile

Contents	Size (cm)	REF	Shipping units (Pieces)
1 table cover	150 x 190	33 801	13
4 towels	30 x 20		
1 instrument table cover	80 x 145		
1 adhesive strip	9 x 50		
2 adhesive drapes, 2-layered, adhesive strip (76 cm)	75 x 90		
1 adhesive drape, 2-layered, adhesive strip (80 cm)	175 x 170		
1 adhesive drape, 2-layered, adhesive strip (80 cm)	140 x 240		

Four-sheet drape for interdisciplinary surgical procedures.

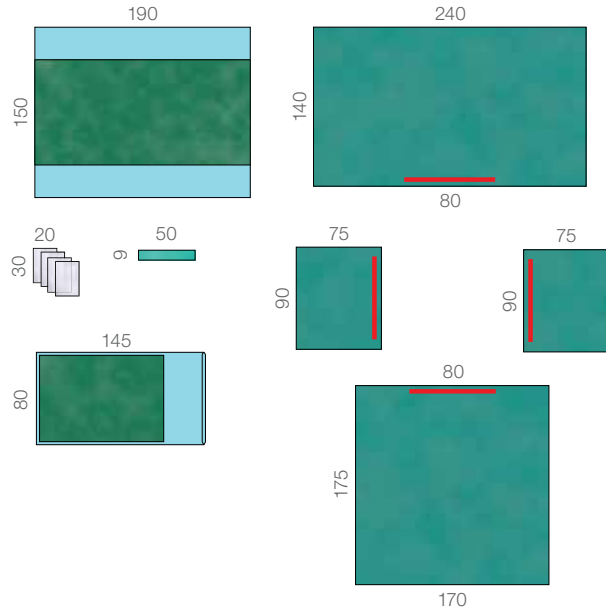

Raucodrape® PRO Universal Set I

sterile

Contents	Size (cm)	REF	Shipping units (Pieces)
1 table cover	150 x 190	33 307	13
4 towels	30 x 40		
1 instrument table cover	80 x 145		
1 adhesive strip	9 x 50		
2 adhesive drapes, 2-layered Plus	75 x 90		
1 adhesive drape, 2-layered Plus, adhesive strip (80 cm)	175 x 180		
1 adhesive drape, 2-layered Plus, three-piece adhesive strip (15 + 70 + 15 cm), with integrated tube retainers	150 x 250		

Four-sheet drape with an additional reinforcement around the operating field for interdisciplinary surgical procedures.

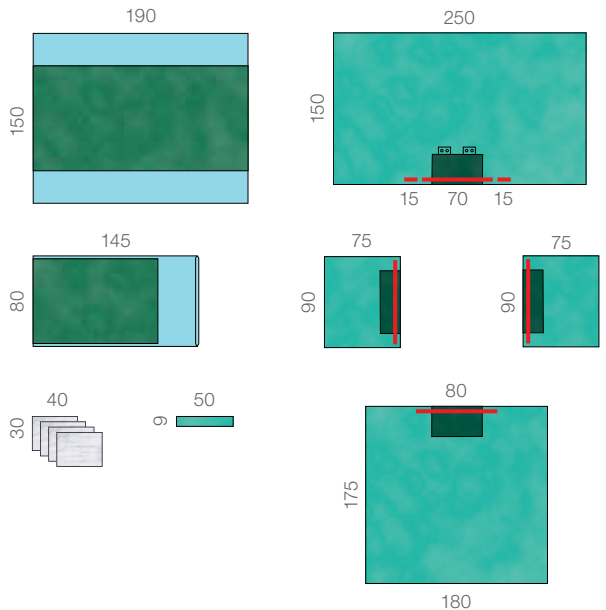

Raucodrape® Universal Sets

General Surgery

Raucodrape® PRO Universal Set I Super sterile

Contents	Size (cm)	REF	Shipping units (Pieces)
1 table cover	150 x 190	33 309	10
4 towels	30 x 40		
1 instrument table cover	80 x 145		
1 adhesive strip	9 x 50		
2 adhesive drapes, 2-layered Plus	90 x 110		
1 adhesive drape, 2-layered Plus, three-piece adhesive strip (15 + 70 + 15 cm)	190 x 225		
1 anaesthesia drape, 2-layered Plus, slit, with armrest cover, with integrated tube retainers	225 x 270 45 x 65		

Four-sheet drape with an additional reinforcement around the operating field, wide lateral drapes and long leg drape, particularly appropriate for major interdisciplinary surgical procedures.

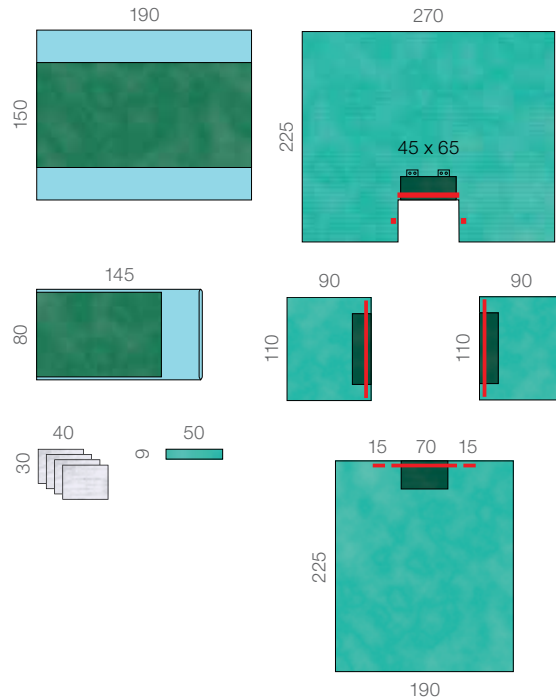

Raucodrape® PRO Universal Set II sterile

Contents	Size (cm)	REF	Shipping units (Pieces)
1 table cover	150 x 190	33 305	11
4 towels	30 x 40		
1 instrument table cover	80 x 145		
1 adhesive strip	9 x 50		
2 adhesive drapes, 3-layered	75 x 90		
1 adhesive drape, 3-layered, adhesive strip (80 cm)	175 x 180		
1 adhesive drape, 3-layered, three-piece adhesive strip (15 + 70 + 15 cm)	150 x 240		

Four-sheet drape for interdisciplinary surgical procedures.

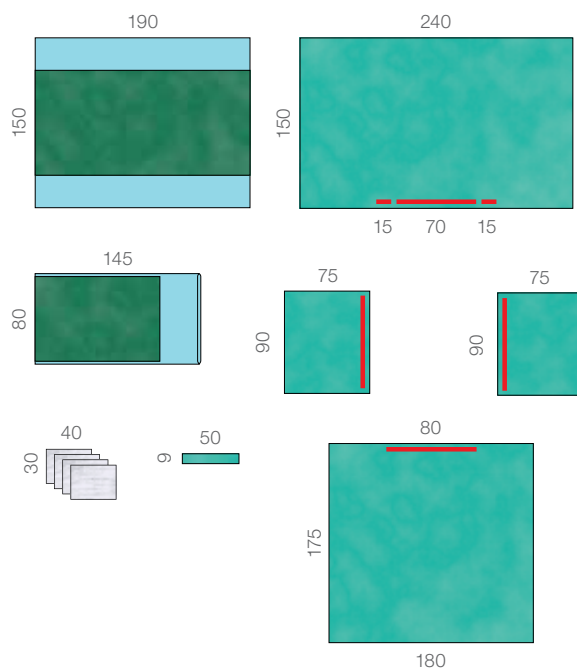

Raucodrape® Split Sheet Sets

General Surgery

Raucodrape® PRO

Basic Split Sheet Set

sterile

Contents	Size (cm)	REF	Shipping units (Pieces)
1 table cover	150 x 190	33 303	15
2 towels	30 x 40		
1 instrument table cover	80 x 145		
1 adhesive drape, 2-layered, three-piece adhesive strip (15 + 70 + 15 cm)	190 x 225		
1 split sheet, 2-layered, slit	175 x <u>250</u> 10 x 65		

Two-sheet drape for surgical procedures in the neck/throat area, e.g. on the thyroid.

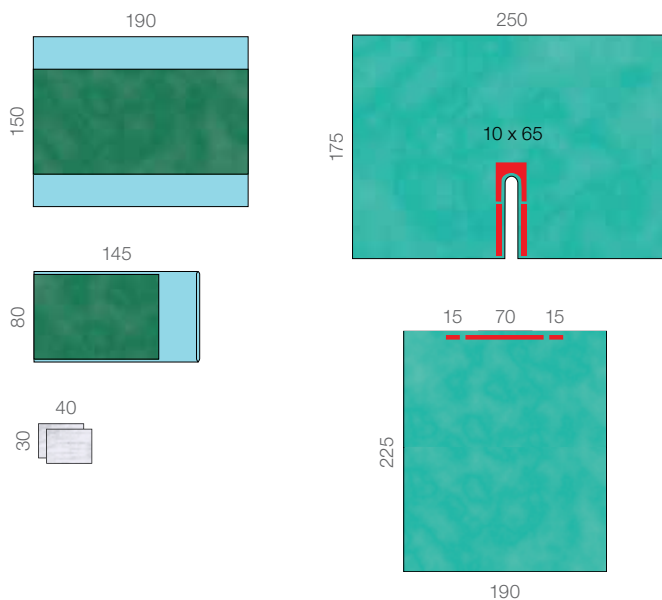

Raucodrape® PRO

Universal Split Sheet Set I

sterile

Contents	Size (cm)	REF	Shipping units (Pieces)
1 table cover	150 x 190	33 310	12
2 towels	30 x 40		
1 instrument table cover	80 x 145		
1 adhesive strip	9 x 50		
1 adhesive drape, 2-layered	75 x <u>90</u>		
1 split sheet, 2-layered Plus, slit	225 x 260 10 x 100		
1 adhesive drape, 2-layered, three-piece adhesive strip (15 + 70 + 15 cm)	150 x <u>240</u>		

Two-sheet drape set for interdisciplinary surgical procedures, particularly suited for vascular procedures on the extremities.

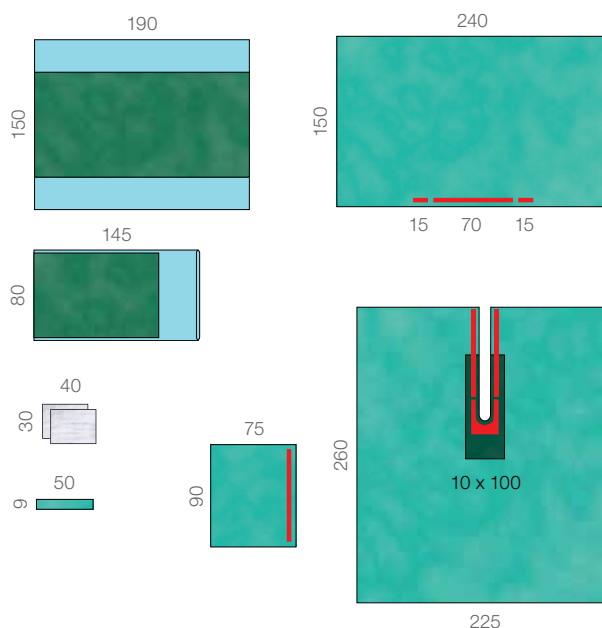

Raucodrape® Split Sheet Sets

General Surgery

Raucodrape® SMART

Universal Split Sheet Set

sterile

Contents	Size (cm)	REF	Shipping units (Pieces)
1 table cover	150 x 190	33 810	12
4 towels	30 x 20		
1 instrument table cover	80 x 145		
1 adhesive strip	9 x 50		
1 split sheet, 2-layered, slit	200 x 260 10 x 80		
1 adhesive drape, 2-layered, adhesive strip (80 cm)	140 x 240		

Two-sheet drape set for interdisciplinary surgical procedures, particularly suited for vascular procedures on the extremities.

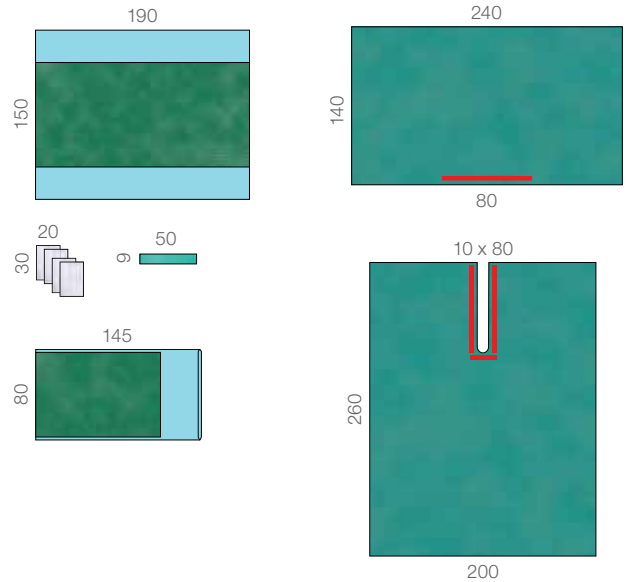

Raucodrape® PRO

Universal Split Sheet Set II

sterile

Contents	Size (cm)	REF	Shipping units (Pieces)
1 table cover	150 x 190	33 318	11
4 towels	30 x 40		
1 instrument table cover	80 x 145		
1 split sheet, 2-layered Plus, slit, adhesive strip (70 cm)	225 x 300 10 x 100		
1 anaesthesia drape, 2-layered Plus, slit, with armrest cover, with integrated tube retainers	225 x 270 45 x 65		

Two-sheet drape for interdisciplinary surgical procedures, particularly suited for surgical procedures in the neck/throat area.

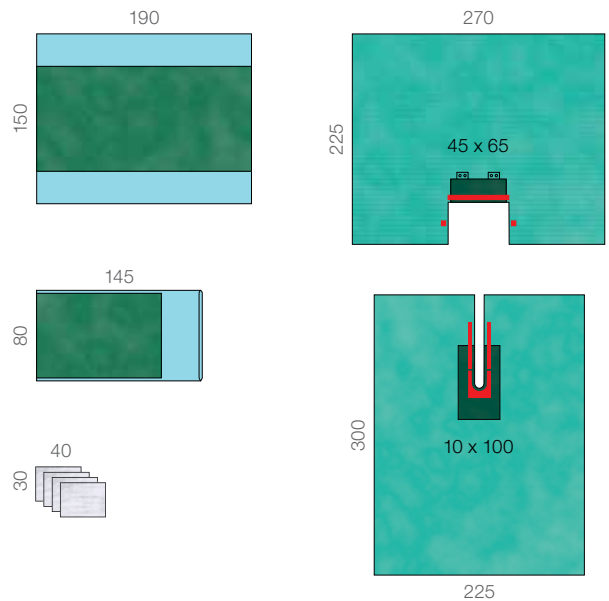

Raucodrape® PRO

Variable Split Sheet Set

sterile

Contents	Size (cm)	REF	Shipping units (Pieces)
1 table cover	150 x 190	33 313	15
4 towels	30 x 40		
1 instrument table cover	80 x 145		
1 split sheet, 2-layered Plus, slit	225 x 240 20 x 20		
1 split sheet, 2-layered, slit	150 x 260 20 x 65		

Two-sheet drape for interdisciplinary surgical procedures in the neck area such as on the thyroid, the carotid arteries, the cervical spine and for pacemaker implantation.

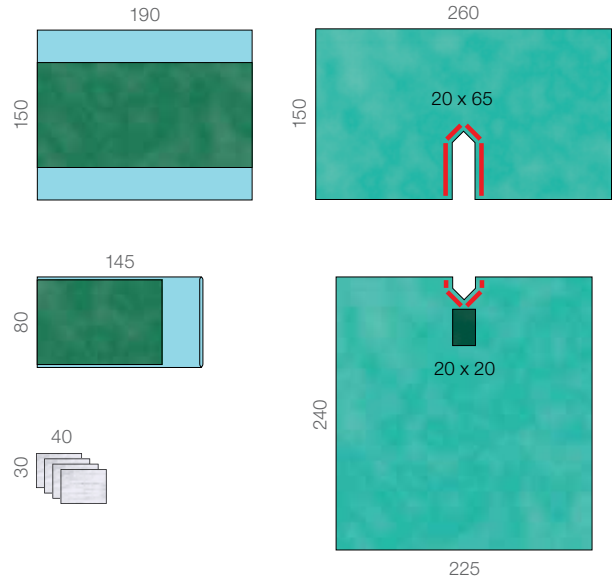

Raucodrape® LAP Sets

General Surgery

Raucodrape® PRO LAP Set I

sterile

Contents	Size (cm)	REF	Shipping units (Pieces)
1 table cover	150 x 190	33 320	14
2 towels	30 x 40		
1 instrument table cover	80 x 145		
1 LAP drape I, for the supine position, with abdominal fenestration, with armrest cover, with integrated tube retainers	260/200 x 335 28 x 32		

All-in-one drape with reinforcement around the operating field for interdisciplinary minimally invasive and other surgical procedures in the flat supine position.

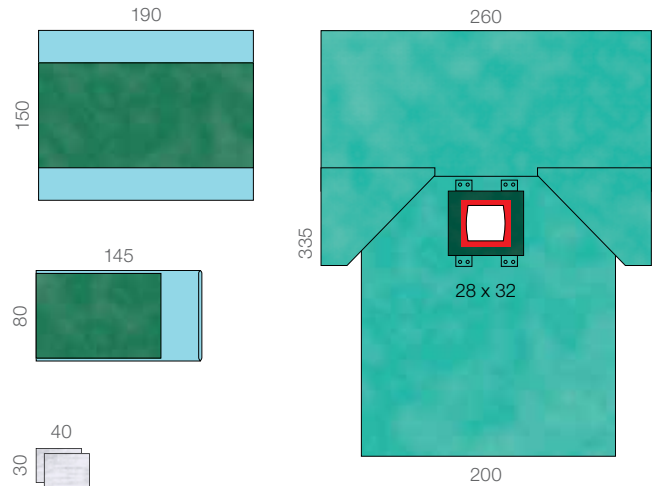

Raucodrape® PRO LAP Set II

sterile

Contents	Size (cm)	REF	Shipping units (Pieces)
1 table cover	150 x 190	33 321	12
2 towels	30 x 40		
1 instrument table cover	80 x 145		
1 LAP drape II, with integrated leggings, with abdominal fenestration, with armrest cover, with integrated tube retainers	260 x 310 125 28 x 32		

All-in-one drape with reinforcement around the operating field for minimally invasive and other surgical procedures in the lithotomy position.

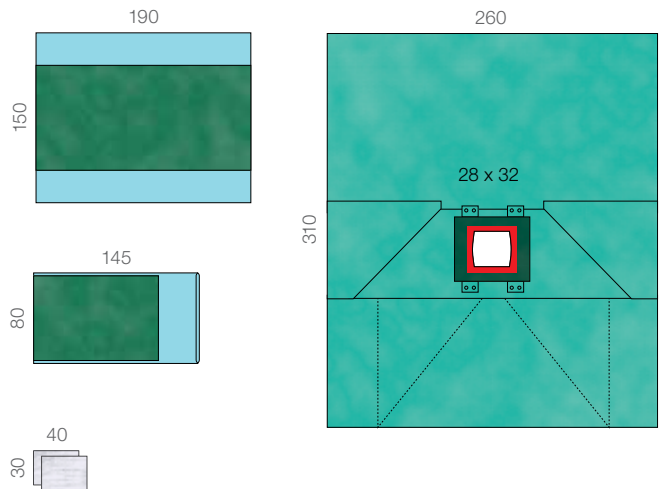

Raucodrape® PRO LAP Set III

sterile

Contents	Size (cm)	REF	Shipping units (Pieces)
1 table cover	150 x 190	33 322	11
2 towels	30 x 40		
1 instrument table cover	80 x 145		
1 LAP drape III, with integrated leggings, with abdominal fenestration, with elastic adhesive film incl. fenestration, with 2-chamber diathermy pouches, with armrest cover, with integrated tube retainers	260 x 310 125 35 x 37 28 x 32		

All-in-one drape for minimally invasive and other surgical procedures in the lithotomy position.

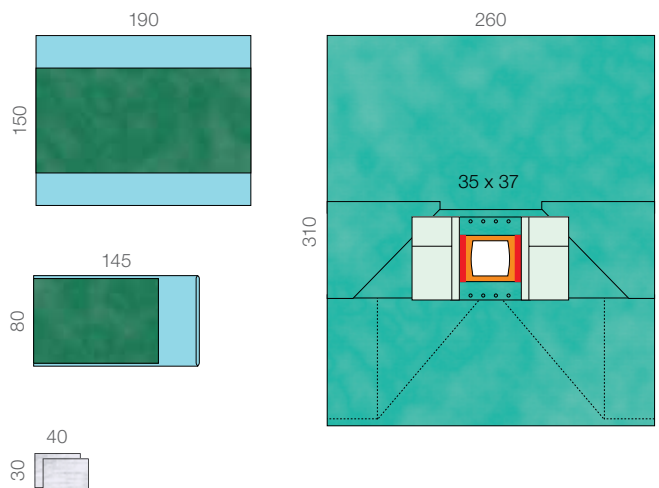

All measurements in cm

Raucodrape® Rectum Sets

General Surgery

Raucodrape® PRO Rectum Set I

sterile

Contents	Size (cm)	REF	Shipping units (Pieces)
1 table cover	150 x 190	33 325	11
4 towels	30 x 40		
1 instrument table cover	80 x 145		
1 rectum drape I, with integrated leggings, with abdominal fenestration, with perineal fenestration, with armrest cover, with integrated tube retainers	260 x 310 125 28 x 32 10 x 15		

All-in-one drape with reinforcement around the operating field for minimally invasive and other surgical procedures in the abdominal/perineal/vaginal area.

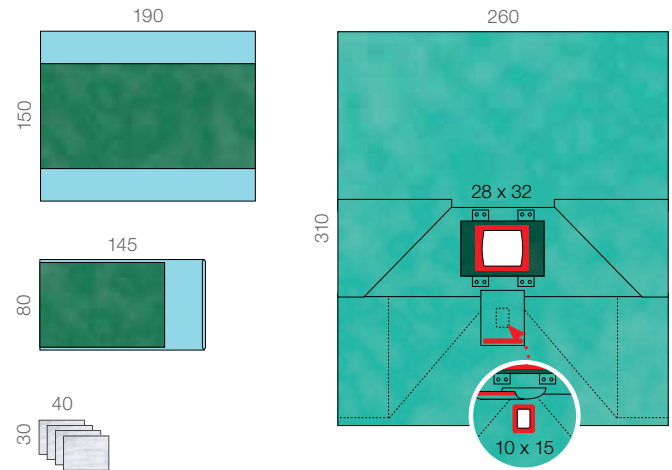

Raucodrape® SMART Abdominal/Perineal Set

sterile

Contents	Size (cm)	REF	Shipping units (Pieces)
1 table cover	150 x 190	33 825	11
4 towels	30 x 20		
1 instrument table cover	80 x 145		
1 adhesive strip	9 x 50		
1 abdominal/perineal drape, with integrated leggings, with abdominal fenestration, with perineal fenestration, with armrest cover	230/260 x 302 125 28 x 32 10 x 15		

All-in-one drape for minimally invasive and other surgical procedures in the abdominal/perineal/vaginal area.

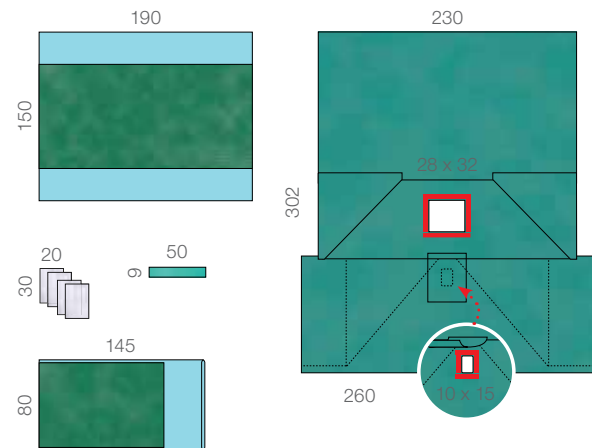

Raucodrape® PRO Rectum Set II

sterile

Contents	Size (cm)	REF	Shipping units (Pieces)
1 table cover	150 x 190	33 326	11
4 towels	30 x 40		
1 instrument table cover	80 x 145		
1 under buttocks drape	75 x 100		
1 rectum drape II, with integrated leggings, with abdominal fenestration, with elastic adhesive film incl. fenestration, with perineal fenestration, with 2-chamber diathermy pouches, with armrest cover, with integrated tube retainers	260 x 310 125 35 x 37 28 x 32 10 x 15		

All-in-one drape for minimally invasive and other surgical procedures in the abdominal/perineal/vaginal area.

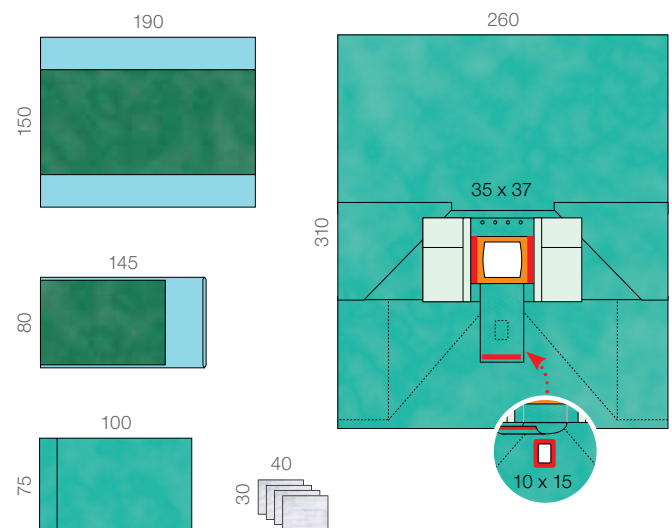

All measurements in cm

Paediatrics



Raucodrape® Paediatric Basic Set

Paediatrics

Raucodrape® PRO Paediatric Basic Set

sterile

Contents	Size (cm)	REF	Shipping units (Pieces)
1 table cover	150 x 190	33 330	14
2 towels	30 x 40		
1 instrument table cover	80 x 145		
1 adhesive strip	9 x 50		
2 adhesive drapes, 2-layered	75 x 90		
1 adhesive drape, 2-layered, adhesive strip (80 cm)	175 x 180		
1 adhesive drape, 2-layered, adhesive strip (80 cm)	150 x 240		

Four-sheet drape for interdisciplinary surgical procedures on children. All adhesive drapes are fitted with a narrower, 3 cm-wide adhesive strip.

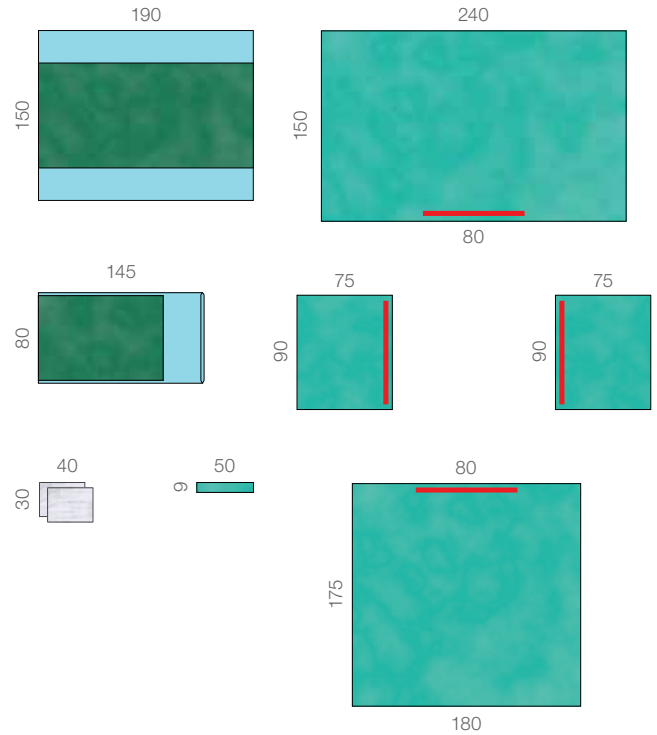

Raucodrape® Fenestrated drape with surgical incision film

Paediatrics

Raucodrape® PRO

Fenestrated drape with surgical incision film

sterile, 2-layered, with surgical incision film

Contents	Size (cm)	REF	Shipping units (Pieces)
fenestrated drape, 2-layered, fenestration, oval, lengthwise, centred, with surgical incision film	120 x 150	33 055	22/44
	7 x 10		

Fenestrated drape for interdisciplinary surgical procedures.

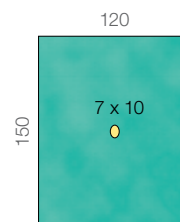

Gynaecology/Urology



Raucodrape® Pfannenstiel Set

Gynaecology/Urology

Raucodrape® PRO Pfannenstiel Set

sterile

Contents	Size (cm)	REF	Shipping units (Pieces)
1 table cover	150 x 190	33 360	12
4 towels	30 x 40		
1 instrument table cover	80 x 145		
1 Pfannenstiel drape, with integrated leggings, with abdominal fenestration, with elastic adhesive film incl. fenestration, with armrest cover, with integrated tube retainers	260 x 310 125 35 x 37 24 x 29		

All-in-one drape for minimally invasive and other surgical procedures in the lithotomy position.

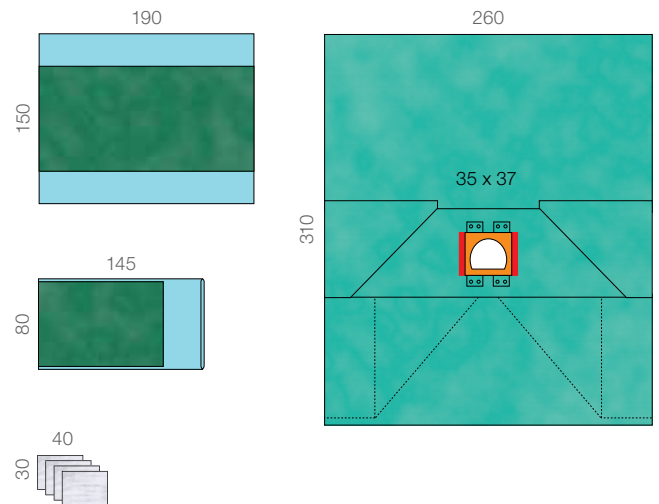

Raucodrape® Rectum Sets

Gynaecology/Urology

Raucodrape® PRO Rectum Set I

sterile

Contents	Size (cm)	REF	Shipping units (Pieces)
1 table cover	150 x 190	33 325	11
4 towels	30 x 40		
1 instrument table cover	80 x 145		
1 rectum drape I, with integrated leggings, with abdominal fenestration, with perineal fenestration, with armrest cover, with integrated tube retainers	260 x 310 125 28 x 32 10 x 15		

All-in-one drape with reinforcement around the operating field for minimally invasive and other surgical procedures in the abdominal/perineal/vaginal area.

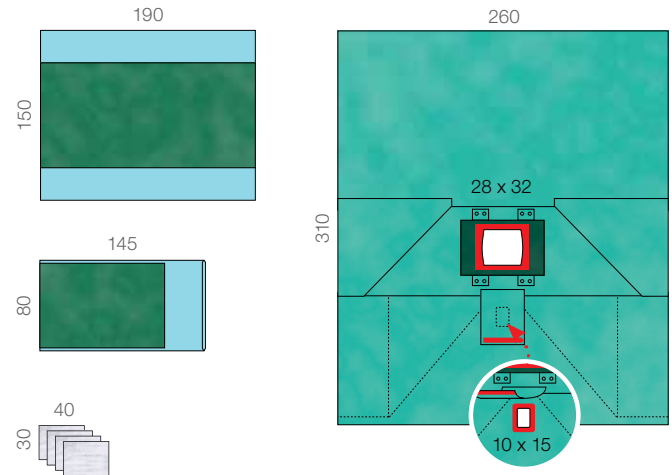

Raucodrape® SMART Abdominal/Perineal Set

sterile

Contents	Size (cm)	REF	Shipping units (Pieces)
1 table cover	150 x 190	33 825	11
4 towels	30 x 20		
1 instrument table cover	80 x 145		
1 adhesive strip	9 x 50		
1 abdominal/perineal drape, with integrated leggings, with abdominal fenestration, with perineal fenestration, with armrest cover	230/260 x 302 125 28 x 32 10 x 15		

All-in-one drape for minimally invasive and other surgical procedures in the abdominal/perineal/vaginal area.

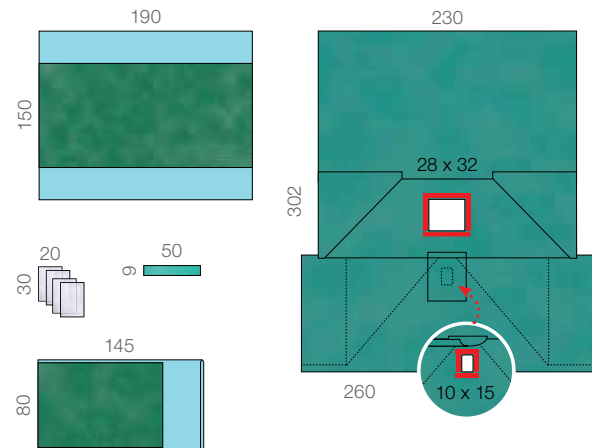

Raucodrape® PRO Rectum Set II

sterile

Contents	Size (cm)	REF	Shipping units (Pieces)
1 table cover	150 x 190	33 326	11
4 towels	30 x 40		
1 instrument table cover	80 x 145		
1 under buttocks drape	75 x 100		
1 rectum drape II, with integrated leggings, with abdominal fenestration, with elastic adhesive film incl. fenestration, with perineal fenestration, with 2-chamber diathermy pouches, with armrest cover, with integrated tube retainers	260 x 310 125 35 x 37 28 x 32 10 x 15		

All-in-one drape for minimally invasive and other surgical procedures in the abdominal/perineal/vaginal area.

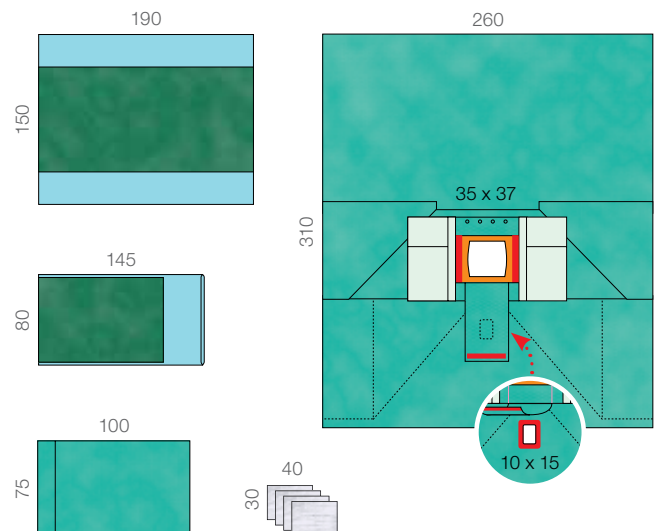

All measurements in cm

Raucodrape® C-section Drapes

Gynaecology/Urology

Raucodrape® SMART Delivery Set I

sterile

Contents	Size (cm)	REF	Shipping units (Sets)
1 OR drape sheet	100 x 150	33 958	18
10 Vliwasoft® nonwoven swabs	10 x 10		
1 towel	30 x 20		
1 OR drape sheet	75 x 90		
1 baby drape	90 x 90		
1 Under buttocks drape with collection pouch	90 x 92		

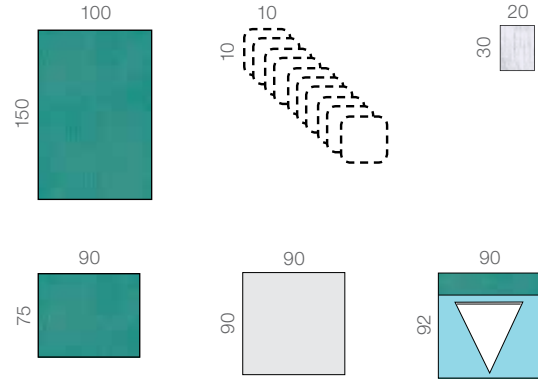

Raucodrape® SMART Delivery Set II

sterile

Contents	Size (cm)	REF	Shipping units (Sets)
1 OR drape sheet	100 x 150	33 959	16
10 Vliwasoft® nonwoven swabs	10 x 10		
1 towel	30 x 20		
1 OR drape sheet	75 x 90		
1 baby drape	90 x 90		
1 Under buttocks drape with collection pouch and 1 nonwoven pouch	90 x 92 85 x 92		

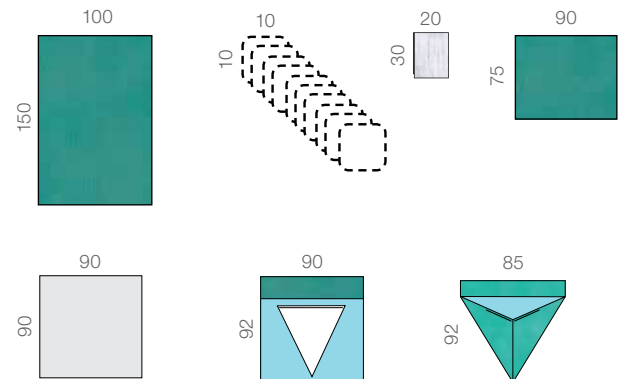

Raucodrape® C-section Drapes

Gynaecology/Urology

Raucodrape® PRO C-section Drape

sterile

Contents	Size (cm)	REF	Shipping units (Pieces)
C-section drape, for the supine position,	260/200 x 335	33 359	8/16
with abdominal fenestration,	27 x 33		
with elastic adhesive film incl. fenestration,	14 x 20		
with integrated fluid collection pouch incl. drainage port,			
with integrated tube retainers with armrest cover			

All-in-one drape for C-sections in the flat supine position with integrated tube retainers.

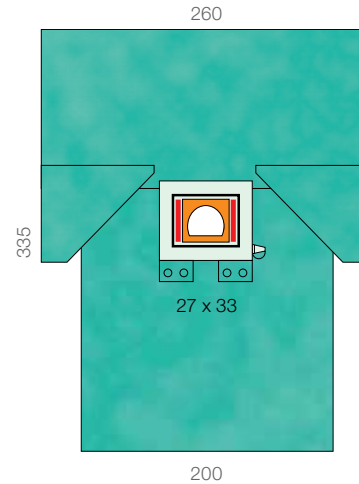

Raucodrape® Baby Drape

sterile

Contents	Size (cm)	REF	Shipping units (Pieces)
Baby drape, fluid-absorbent nonwoven material	90 x 100	33 160	18/72

Fluid-absorbent, soft baby drape for receiving an infant.

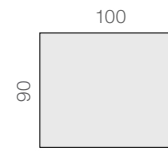

Raucodrape® PRO C-section Set I

sterile

Contents	Size (cm)	REF	Shipping units (Pieces)
1 table cover	150 x 190	33 361	11
4 towels	30 x 40		
1 instrument table cover	80 x 145		
1 baby drape, fluid-absorbent nonwoven material	90 x 100		
1 C-section drape I, for the supine position, with abdominal fenestration, with elastic adhesive film incl. fenestration, with integrated fluid collection pouch incl. drainage port, with integrated tube retainers, with armrest cover	260/200 x 335 27 x 33 14 x 20		

All-in-one drape for C-sections in the flat supine position with integrated tube retainers.

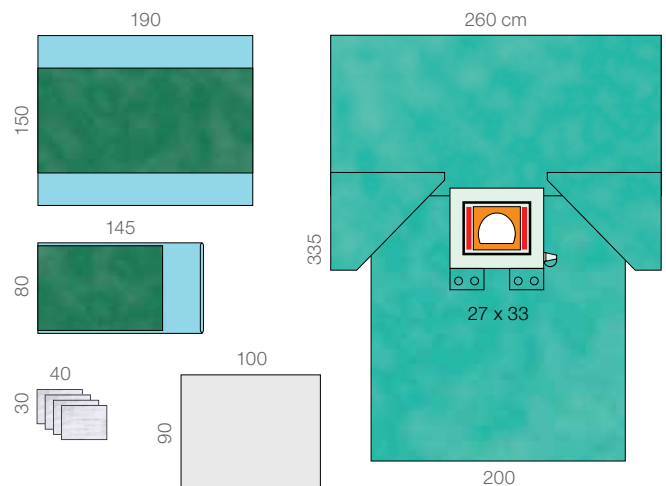

Raucodrape® SMART C-section Set

sterile

Contents	Size (cm)	REF	Shipping units (Pieces)
1 table cover	150 x 190	33 861	12
4 towels	30 x 20		
1 instrument table cover	80 x 145		
1 adhesive strip	9 x 50		
1 baby drape, fluid-absorbent nonwoven material	90 x 90		
1 C-section drape, for the supine position, with abdominal fenestration, with integrated surgical incision film, with integrated fluid collection pouch incl. drainage port, with armrest cover	230/200 x 312 27 x 33		

All-in-one drape for C-sections in the flat supine position.

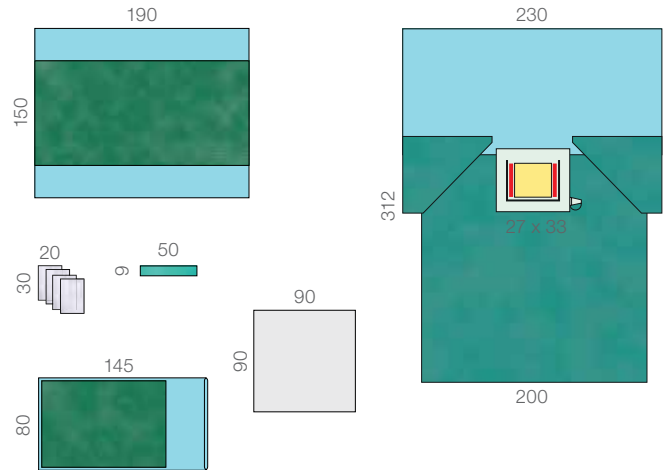

Raucodrape® PRO C-section Set II

sterile

Contents	Size (cm)	REF	Shipping units (Pieces)
1 table cover	150 x 190	33 362	11
4 towels	30 x 40		
1 instrument table cover	80 x 145		
1 baby drape, fluid-absorbent nonwoven material	90 x 100		
1 C-section drape II, with integrated leggings, with abdominal fenestration, with elastic adhesive film incl. fenestration, with integrated fluid collection pouch incl. drainage port, with armrest cover	260 x 310 125 27 x 33 14 x 20		

All-in-one drape for C-sections in the lithotomy position.

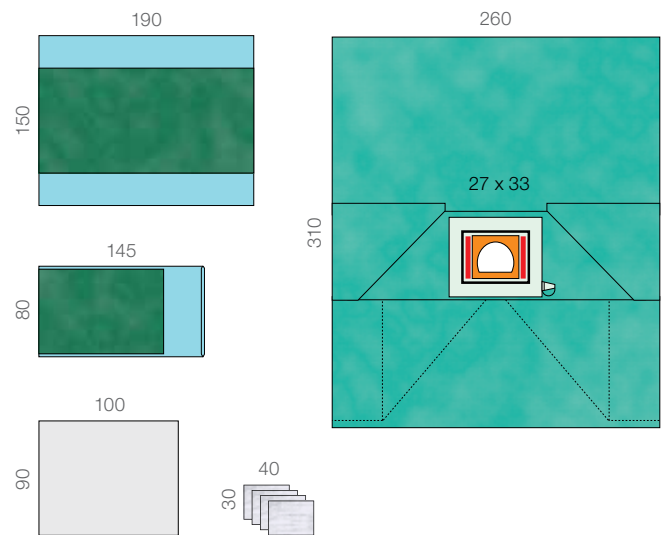

Raucodrape®

Gynaecology/Cystoscopy Drapes

Gynaecology/Urology

Raucodrape® PRO

Gynaecology/Cystoscopy Set

sterile

	Contents	Size (cm)	REF	Shipping units (Pieces)
1	table cover	120 x 140	33 363	8/16
2	leg protectors	75 x 120		
1	gynaecology/cystoscopy drape, with perineal fenestration, centred	90 x 175 9 x 15		

Multi-sheet patient drape for minor procedures in the lithotomy position (e.g. conisation, cerclage and cystoscopy).

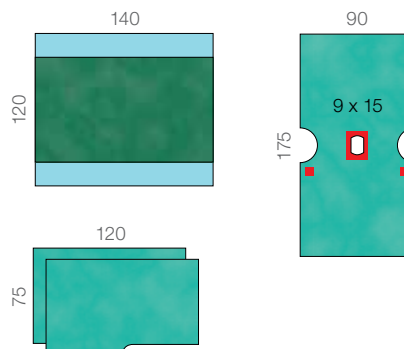

Raucodrape® SMART Cystoscopy Set

sterile

	Contents	Size (cm)	REF	Shipping units (Pieces)
1	table cover	120 x 140	33 863	40
2	leg protectors	75 x 120		
1	cystoscopy Drape, with perineal fenestration, centred	90 x 175 9 x 15		

Multi-sheet patient drape for minor procedures in the lithotomy position (e.g. conisation, cerclage and cystoscopy).

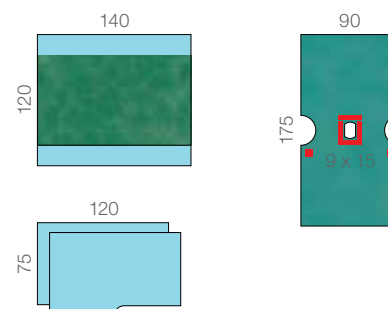

Raucodrape® PRO

Gynaecology/Cystoscopy Drape

sterile

	Contents	Size (cm)	REF	Shipping units (Pieces)
	gynaecology/cystoscopy drape, with perineal fenestration, centred	90 x 175 9 x 15	33 039	35/70

All-in-one drape for minor procedures in the lithotomy position.

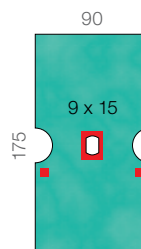

Raucodrape® Lithotomy Set

Gynaecology/Urology

Raucodrape® PRO Lithotomy Set

sterile

Contents	Size (cm)	REF	Shipping units (Pieces)
1 table cover	150 x 190	33 366	21
2 towels	30 x 40		
1 adhesive strip	9 x 50		
1 under buttocks drape, 2-layered	75 x 100		
1 lithotomy drape, with integrated leggings, with perineal fenestration	175/260 x 210		

All-in-one drape for interdisciplinary surgical procedures in the lithotomy position.

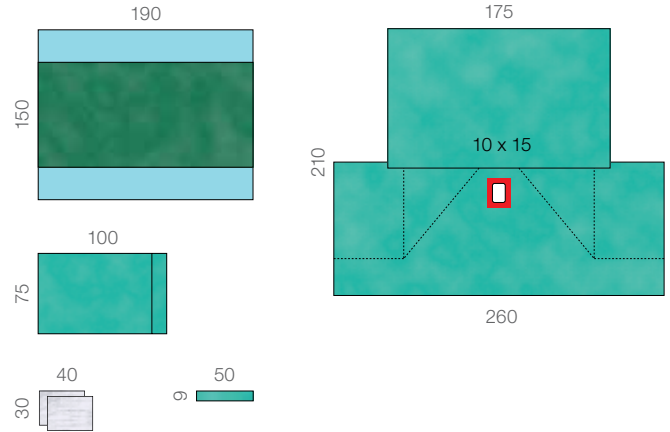

Raucodrape® Gynaecology/Urology Sets

Gynaecology/Urology

Raucodrape® PRO Gynaecology Set I

sterile

Contents	Size (cm)	REF	Shipping units (Pieces)
1 table cover	150 x 190	33 364	14
2 towels	30 x 40		
1 instrument table cover	80 x 145		
1 hook-and-loop fastener	2.5 x 20/24		
1 adhesive drape, PE film	50 x 50		
1 gynaecology drape I, with integrated leggings, with perineal fenestration	240/260 x 230 125 10 x 15		

All-in-one drape for major interdisciplinary surgical procedures in the lithotomy position.

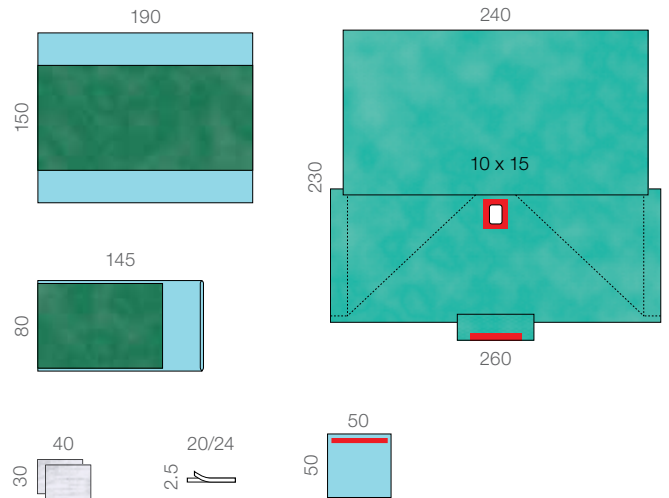

Raucodrape® SMART Gynaecology/Urology Set

sterile

Contents	Size (cm)	REF	Shipping units (Pieces)
1 table cover	150 x 190	33 866	24
4 towels	30 x 20		
1 adhesive strip	9 x 50		
1 adhesive drape, PE film	50 x 50		
1 gynaecology drape, with integrated leggings, with perineal fenestration	175/260 x 210 125 10 x 15		

All-in-one drape for interdisciplinary surgical procedures in the lithotomy position.

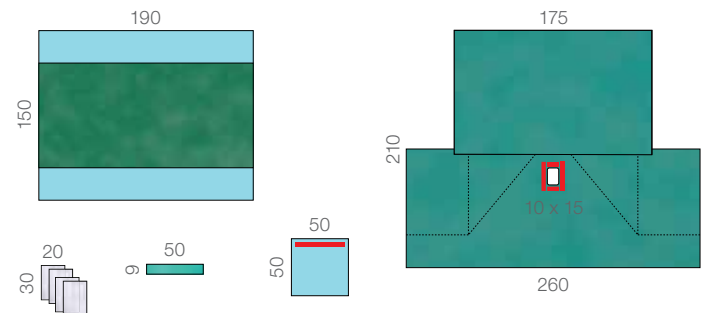

Raucodrape® PRO Gynaecology Set II

sterile

Contents	Size (cm)	REF	Shipping units (Pieces)
1 table cover	150 x 190	33 365	14
2 towels	30 x 40		
1 instrument table cover	80 x 145		
1 adhesive strip	9 x 50		
1 adhesive drape, PE film	50 x 50		
1 gynaecology drape II, with integrated leggings, with perineal fenestration, with reinforcement around the operating field, with integrated fluid collection pouch incl. sieve and drainage port	240/260 x 230 125 10 x 15		

All-in-one drape for major interdisciplinary surgical procedures in the lithotomy position.

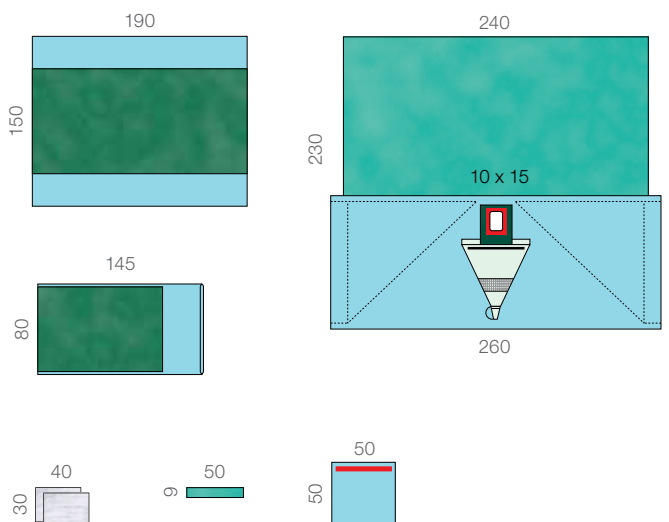

__ indicates the side with the adhesive area

All measurements in cm

Raucodrape® T.U.R. Sets

Gynaecology/Urology

Raucodrape® PRO T.U.R. Set I

sterile

Contents	Size (cm)	REF	Shipping units (Pieces)
1 table cover	150 x 190	33 376	21
2 towels	30 x 40		
1 hook-and-loop fastener	2.5 x 20/24		
1 T.U.R. drape I, with integrated leggings, with perineal fenestration, with suprapubic opening, with integrated fluid collection pouch incl. sieve and drainage port, with latex-free finger stall	225/260 x 210 125 5 8		

All-in-one drape for all transurethral procedures.

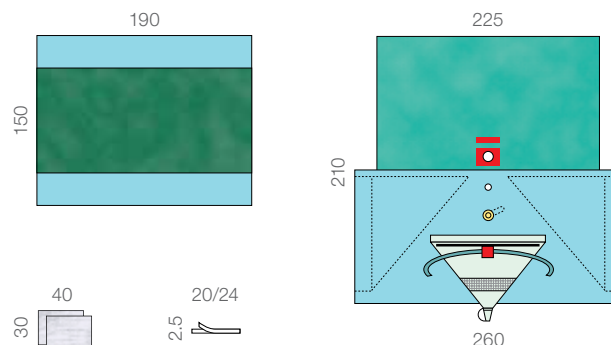

Raucodrape® SMART T.U.R. Set

sterile

Contents	Size (cm)	REF	Shipping units (Pieces)
1 table cover	150 x 190	33 867	29
4 towels	30 x 20		
1 adhesive strip	9 x 50		
1 T.U.R. drape, with integrated leggings, with perineal fenestration, with suprapubic opening, with integrated fluid collection pouch incl. sieve and drainage port, with latex-free finger stall	175/260 x 210 125 5 8		

All-in-one drape for all transurethral procedures.

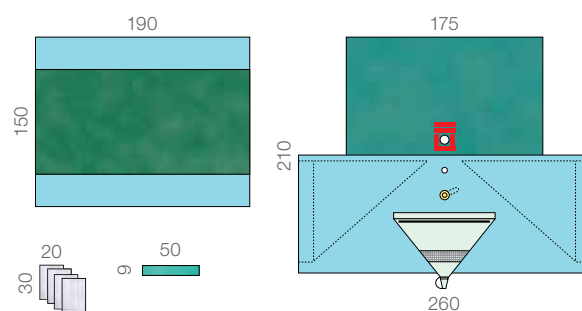

Raucodrape® PRO T.U.R. Set II

sterile

Contents	Size (cm)	REF	Shipping units (Pieces)
1 table cover	150 x 190	33 368	18
2 towels	30 x 40		
1 hook-and-loop fastener	2.5 x 20/24		
1 T.U.R. drape II, with integrated leggings, with perineal fenestration, with suprapubic opening, with integrated sieve, with latex-free finger stall	175/260 x 245 125 7 x 10 8		

All-in-one drape for all transurethral procedures.

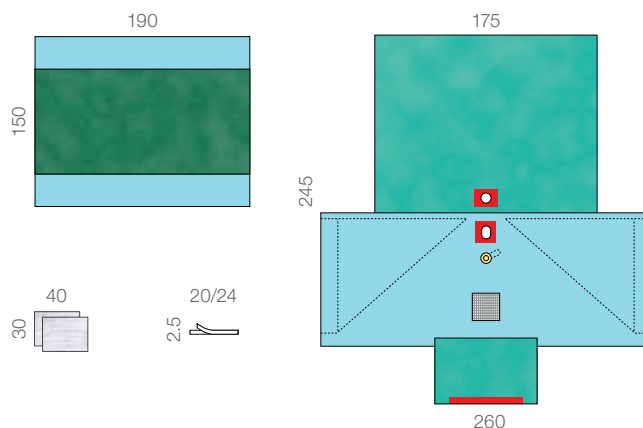

All measurements in cm

Orthopaedics/Traumatology



Raucodrape® Universal Split Sheet Set

Orthopaedics/Traumatology

Raucodrape® PRO

Universal Split Sheet Set I

sterile

Contents	Size (cm)	REF	Shipping units (Pieces)
1 table cover	150 x 190	33 310	12
2 towels	30 x 40		
1 instrument table cover	80 x 145		
1 adhesive strip	9 x 50		
1 adhesive drape, 2-layered	75 x 90		
1 split sheet, 2-layered Plus, slit	225 x 260 10 x 100		
1 adhesive drape, 2-layered, three-piece adhesive strip (15 + 70 + 15 cm)	150 x 240		

Two-sheet drape set for interdisciplinary surgical procedures, particularly suited for vascular procedures on the extremities.

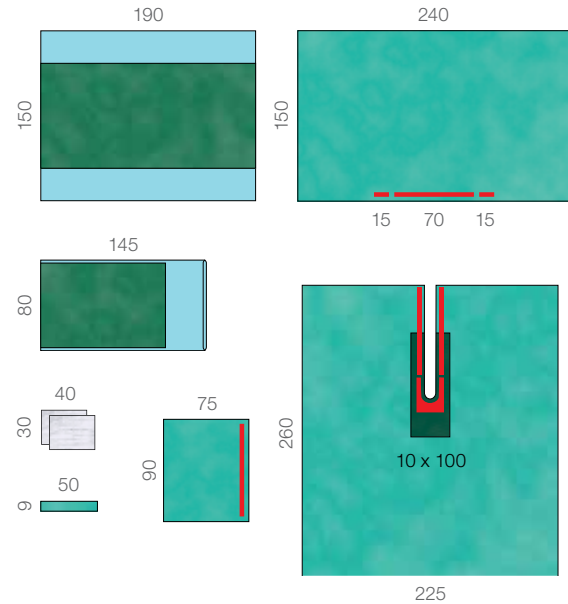

Raucodrape® Orthopaedics/Hip Sets

Orthopaedics/Traumatology

Raucodrape® SMART Orthopaedics Set

sterile

Contents	Size (cm)	REF	Shipping units (Pieces)
1 table cover	150 x 190	33 841	10
4 towels	30 x 20		
1 adhesive strip	9 x 50		
1 instrument table cover	80 x 145		
1 orthopaedic stockinette	33 x 110		
2 adhesive film strip	10 x 50		
1 OR drape sheet, 2-layered	150 x 150		
1 split sheet, 2-layered Plus, slit	200 x 240 10 x 80		
1 adhesive drape, 2-layered, adhesive strip (80 cm)	175 x 260		

Multi-sheet split-sheet set with reinforcement around the operating field for surgical procedures in the hip region and the limbs.

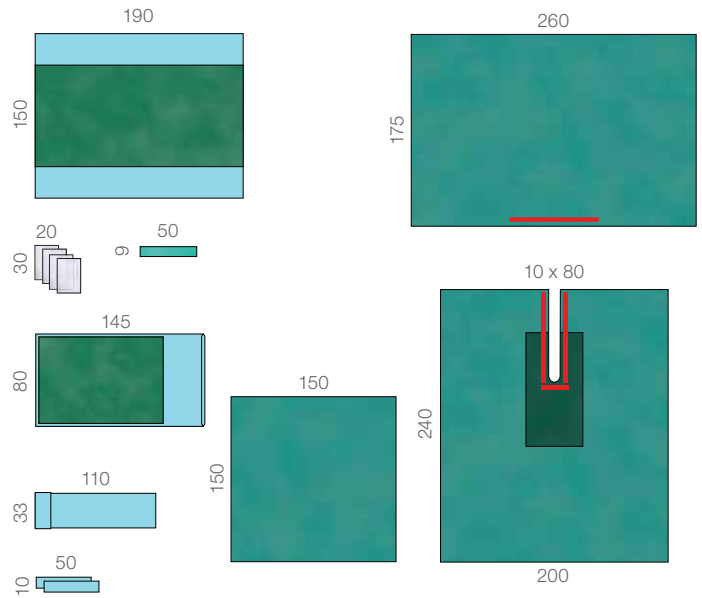

Raucodrape® PRO Hip Set I

sterile

Contents	Size (cm)	REF	Shipping units (Pieces)
1 table cover	150 x 190	33 387	9
4 towels	30 x 40		
1 instrument table cover	80 x 145		
1 adhesive strip	9 x 50		
1 adhesive drape, 2-layered	75 x 90		
1 OR drape sheet, 2-layered	150 x 180		
1 split sheet, 2-layered Plus, slit	225 x 270 10 x 100		
1 anaesthesia drape, 2-layered Plus, slit, with integrated tube retainers, with armrest cover	225 x 270 45 x 65		

Multi-sheet split-sheet set with reinforcement around the operating field for interdisciplinary surgical procedures in the hip region and the limbs.

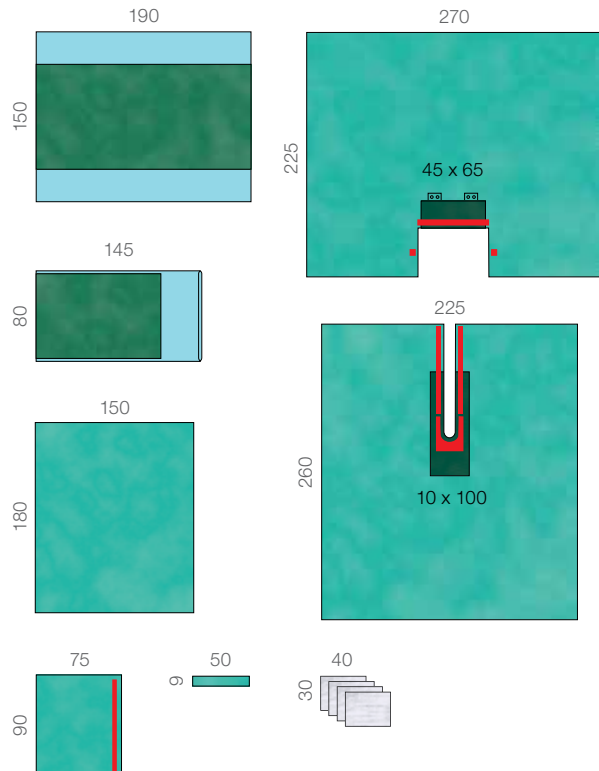

— indicates the side with the adhesive area

All measurements in cm

Raucodrape® PRO Hip Set II

sterile

Contents	Size (cm)	REF	Shipping units (Pieces)
1 table cover	150 x 190	33 388	8
4 towels	30 x 40		
1 instrument table cover Special	80 x 145		
1 adhesive strip	9 x 50		
1 adhesive drape, 2-layered	75 x 90		
1 OR drape sheet, 2-layered	150 x 180		
1 orthopaedic stockinette	33 x 110		
2 adhesive film strip	10 x 50		
1 split sheet, 2-layered Plus, slit,	225 x 280 10 x 100	33 388	8
1 anaesthesia drape, 2-layered Plus, slit, with integrated tube retainers, with armrest cover	225 x 270 45 x 65		

Multi-sheet split-sheet set with reinforcement around the operating field for surgical procedures in the hip region and the limbs.

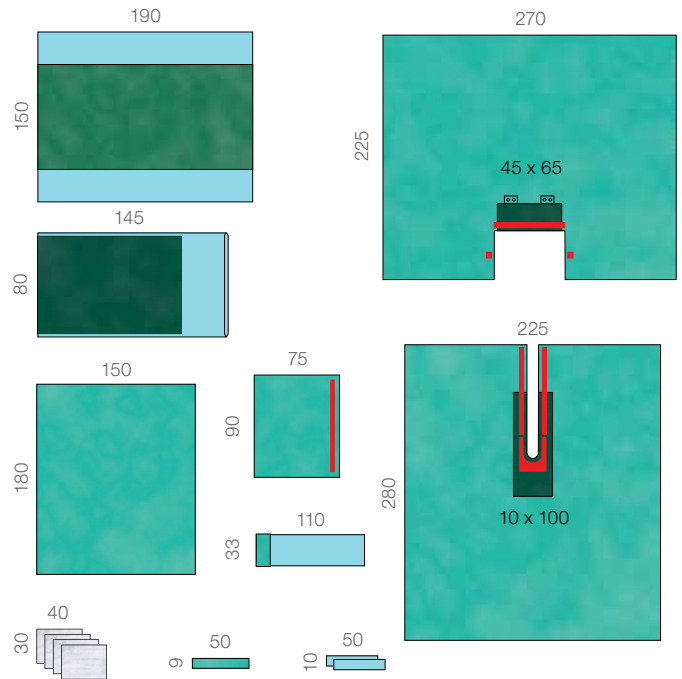

Raucodrape® PRO Hip Set III

sterile

Contents	Size (cm)	REF	Shipping units (Pieces)
1 table cover	150 x 190	162 389	10
2 towels	30 x 40		
1 instrument table cover Special	80 x 145		
1 hip drape, 2-layered Plus, with PE film on both sides, with elastic fenestration, with 1-chamber diathermy pouches on both sides, with armrest cover, with integrated tube fixations	285/400 x 400 18 x 22		

Multi-sheet split-sheet set with reinforcement around the operating field for surgical procedures in the hip region and the limbs.

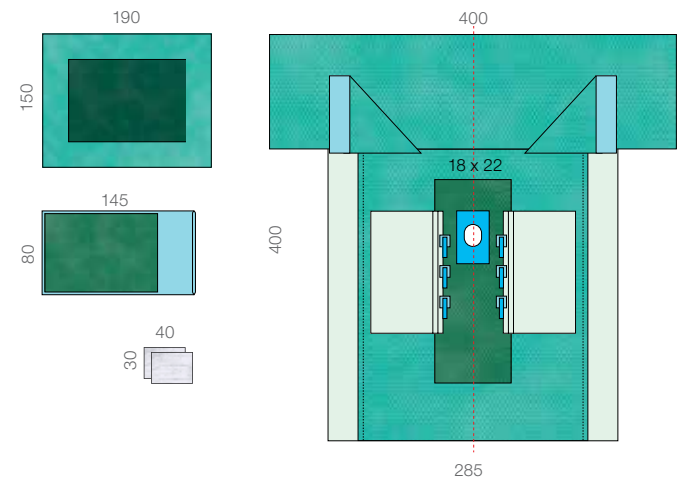

Raucodrape® Hip Arthroscopy Set

Orthopaedics/Traumatology

Raucodrape® PRO Hip Arthroscopy Set

sterile

Contents	Size (cm)	REF	Shipping units (Pieces)
1 table cover Special	150 x 190	33 357	13
4 towels	30 x 40		
1 hip arthroscopy drape, 2-layered, fenestration,	288 x 360		
with elastic adhesive film incl. fenestration, with integrated fluid collection pouch incl. sieve and drainage port, with two diathermy pouches	30 x 30 20 x 20		

All-in-one drape for minimally invasive and other surgical procedures on the hip joint.

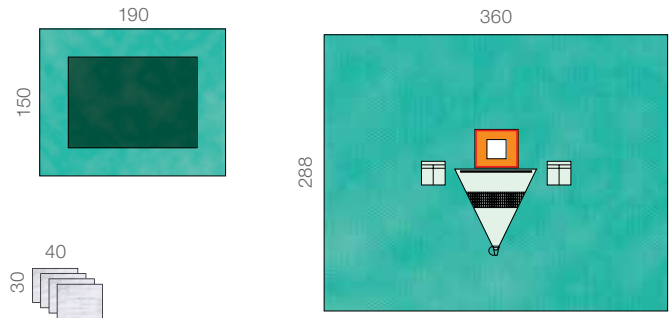

Raucodrape® Extremity Sets

Orthopaedics/Traumatology

Raucodrape® PRO Extremity Set I

sterile

Contents	Size (cm)	REF	Shipping units (Pieces)
1 table cover	150 x 190	33 343	11
2 towels	30 x 40		
1 instrument table cover	80 x 145		
1 adhesive drape, 2-layered	75 x 75		
1 OR drape sheet, 2-layered	150 x 180		
1 extremity drape, 2-layered Plus, with elastic fenestration, with integrated tube retainers	225 x 320 7		

Multi-sheet patient drape incl. extremity drape with reinforcement around the operating field and an elastic cuff for minimally invasive and other surgical procedures on the limbs.

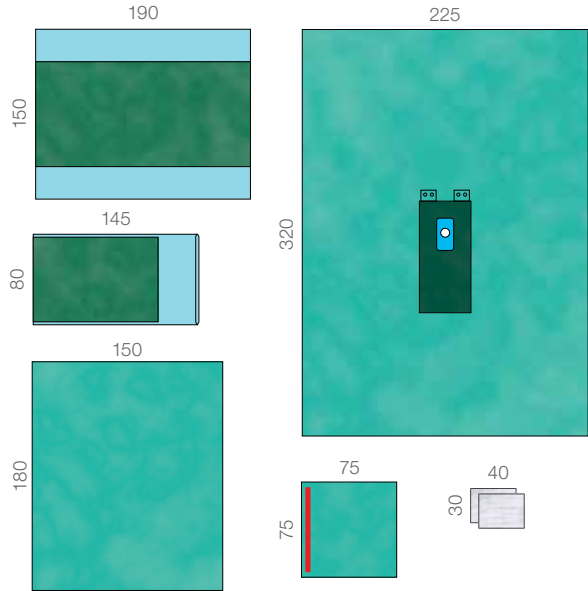

Raucodrape® PRO Extremity Set II

sterile

Contents	Size (cm)	REF	Shipping units (Pieces)
1 table cover	150 x 190	33 344	11
2 towels	30 x 40		
1 instrument table cover	80 x 145		
1 OR drape sheet, 2-layered	150 x 180		
1 orthopaedic stockinette	33 x 55		
1 adhesive film strip	10 x 50		
1 extremity drape, 2-layered Plus, with elastic fenestration, with integrated tube retainers	225 x 320 7		

Multi-sheet patient drape incl. extremity drape with reinforcement around the operating field and an elastic cuff for minimally invasive and other surgical procedures on the limbs.

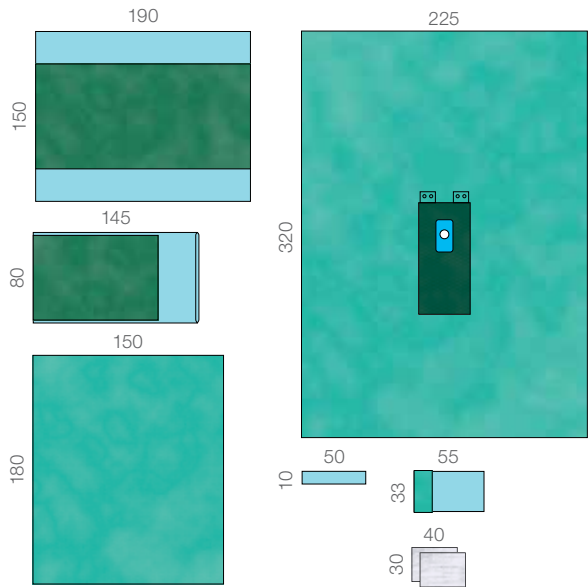

Raucodrape® SMART Extremity Set

sterile

Contents	Size (cm)	REF	Shipping units (Pieces)
1 table cover	150 x 190	33 844	12
4 towels	30 x 20		
1 OR drape sheet, 2-layered	150 x 150		
1 instrument table cover	80 x 145		
1 orthopaedic stockinette	33 x 55		
1 adhesive film strip	10 x 50		
1 adhesive strip	9 x 50		
1 extremity drape, 2-layered Plus, with elastic fenestration	200 x 305 7		

Multi-sheet patient drape incl. extremity drape with reinforcement around the operating field and an elastic cuff for minimally invasive and other surgical procedures on the limbs.

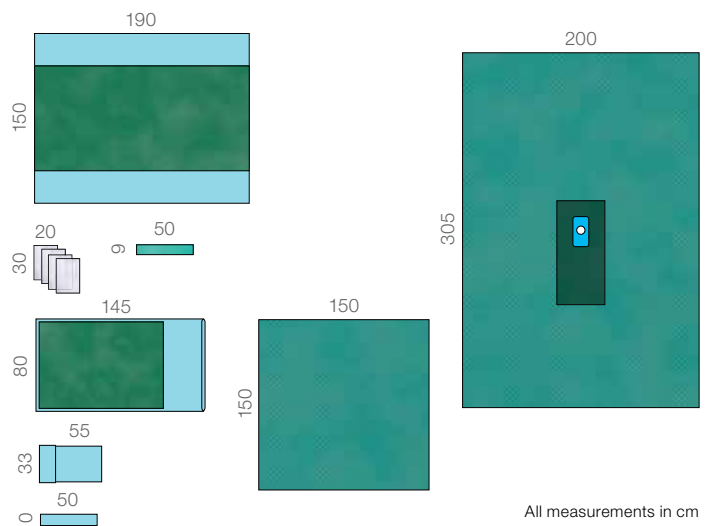

__ indicates the side with the adhesive area

All measurements in cm

Raucodrape® Extremity Sets

Orthopaedics/Traumatology

Raucodrape® PRO Extremity Set III

sterile

Contents	Size (cm)	REF	Shipping units (Pieces)
1 table cover	150 x 190	33 345	10
2 towels	30 x 40		
1 instrument table cover Special	80 x 145		
1 adhesive strip	9 x 50		
1 OR drape sheet, 2-layered	150 x 180		
1 extremity drape, 2-layered Plus, with elastic fenestration, with armrest cover, with integrated tube retainers	270/200 x 335 7		

Multi-sheet patient drape incl. extremity drape with reinforcement around the operating field and an elastic cuff for minimally invasive and other surgical procedures on the lower limbs.

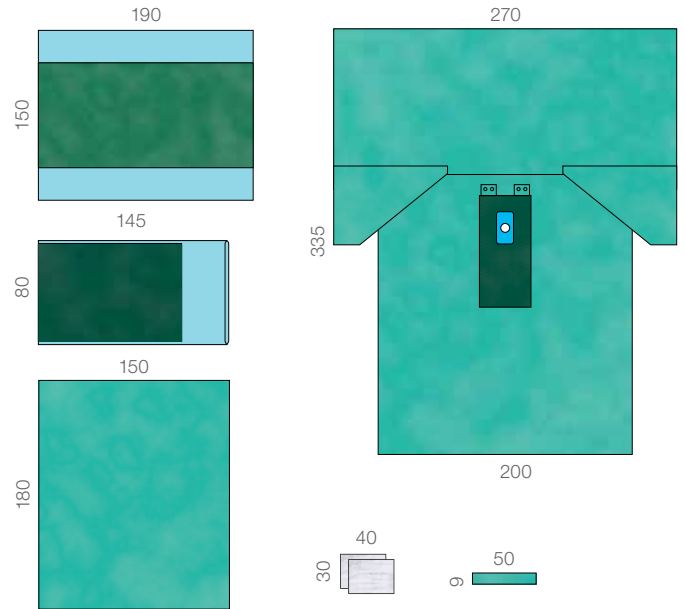

Raucodrape® PRO Extremity Set Hand/Foot

sterile

Contents	Size (cm)	REF	Shipping units (Pieces)
1 table cover	150 x 190	33 347	17
2 towels	30 x 40		
1 instrument table cover	80 x 145		
1 extremity drape hand/foot, 2-layered Plus, with elastic fenestration, with integrated tube retainers	225 x 300 3		

Extremity drape with reinforcement around the operating field, elastic and off-centre cuff for minimally invasive and surgical procedures on hands and feet.

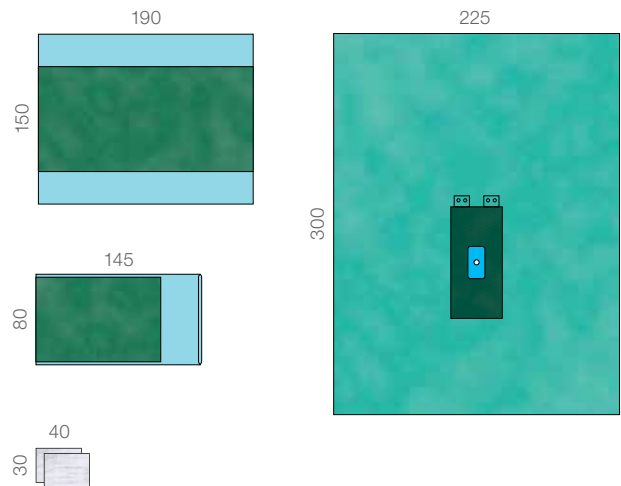

Raucodrape® PRO Hand Surgery Set

sterile

Contents	Size (cm)	REF	Shipping units (Pieces)
1 table cover	150 x 190	33 349	14
1 instrument table cover	80 x 145		
1 hand surgery drape, 2-layered Plus, with elastic fenestration, with extra-wide anaesthesia drape, with integrated tube retainers	370/175 x 285 3		

Extremity drape with an integrated hand table cover, reinforcement around the operating field and an elastic cuff for minimally invasive and other surgical procedures on the upper limbs.

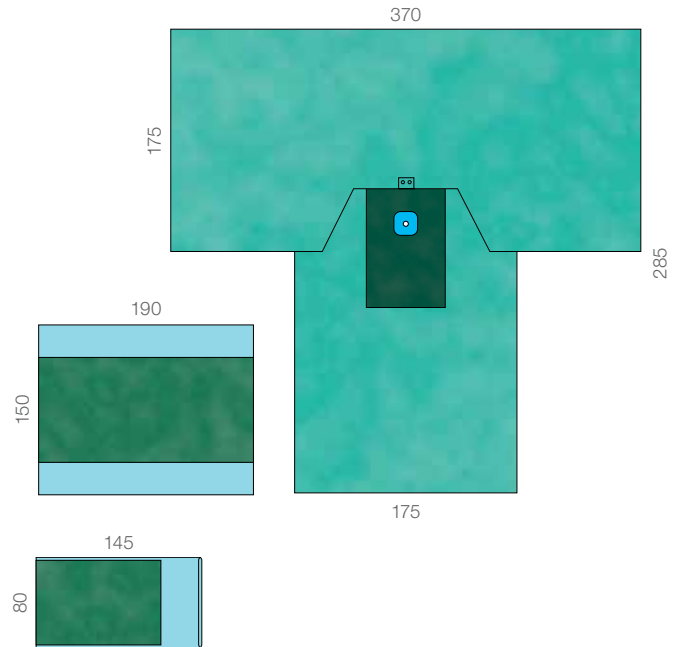

Raucodrape® SMART Hand Surgery Set

sterile

Contents	Size (cm)	REF	Shipping units (Pieces)
1 table cover	150 x 190	139 952	14
1 OR drape sheet, 2-layered	100 x 150		
1 hand surgery drape, with elastic fenestration, with wide anaesthesia drape	340/175 x 285 3		

Extremity drape with an elastic cuff for minimally invasive and other surgical procedures on the upper limbs.

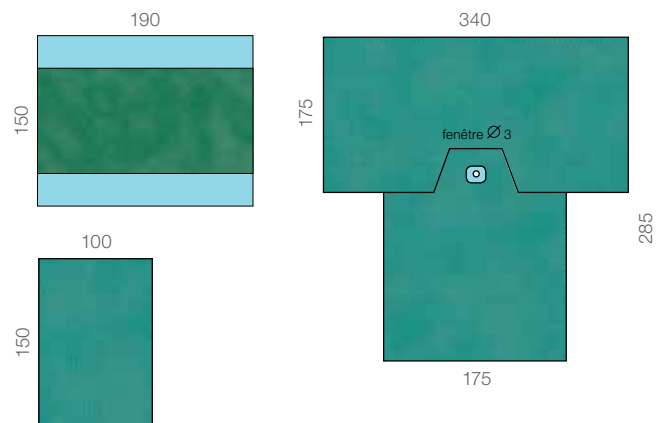

Raucodrape® Extremity Drapes

Orthopaedics/Traumatology

Raucodrape® PRO Extremity Drapes

sterile

Contents	Size (cm)	REF	Shipping units (Pieces)
2-layered			
extremity drape, 2-layered, elastic fenestration, round, centred	200 x 300	33 085	13/26
	7		
extremity drape, 2-layered, elastic fenestration, round, centred	225 x 320	33 083	12/24
	7		
2-layered Plus, with integrated tube retainers			
extremity drape, 2-layered Plus, elastic fenestration, round, centred with integrated tube retainers	225 x 320	33 084	11/22
	7		

Extremity drapes with and without reinforcement around the operating field and an elastic cuff for surgical procedures on the limbs.



Raucodrape® PRO Extremity Drape, bilateral

non-sterile, available for individual sets only

Contents	Size (cm)	Component No. Individual Sets
extremity drape bilateral, 2-layered Plus, with elastic fenestration, with integrated tube retainers	225 x 320	2 002 740
	6	

Bilateral extremity drape with reinforcement around the operating field and elastic cuffs for surgical procedures on the limbs.

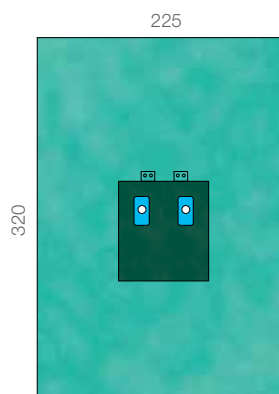

Raucodrape® PRO

Extremity Drapes Hand/Foot

sterile

Contents	Size (cm)	REF	Shipping units (Pieces)
2-layered			
extremity drape, 2-layered, elastic fenestration, round, centred	100 x 175	33 080	20/40
	3		
extremity drape, 2-layered, elastic fenestration, round, centred	150 x 180	33 081	18/36
	3		
2-layered Plus, with integrated tube retainers			
extremity drape hand/foot, 2-layered Plus, elastic fenestration, off-centre, with integrated tube retainers	225 x 300	33 082	10/20
	3		

Extremity drapes with and without reinforcement around the operating field and an elastic cuff for surgical procedures on hands and feet.

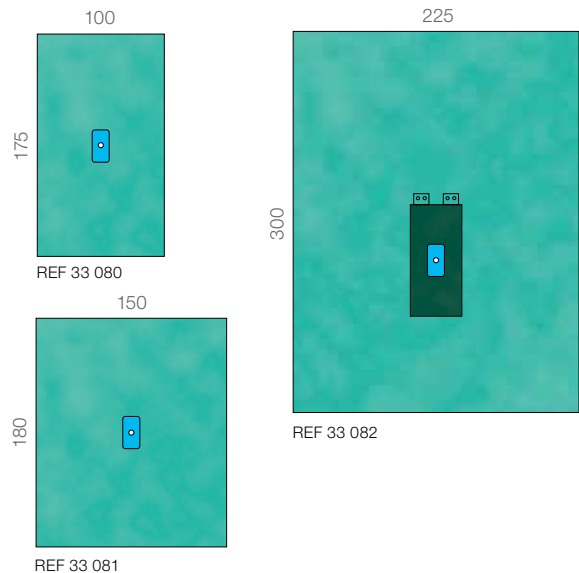

Raucodrape® SMART

Extremity Drape Hand/Foot

sterile

Contents	Size (cm)	REF	Shipping units (Pieces)
1 table cover	120 x 140	33 780	19
1 extremity drape hand/foot, 2-layered, elastic fenestration, off-centre	200 x 300		
	3		

Extremity drape with elastic cuff for surgical procedures on the hands and feet.

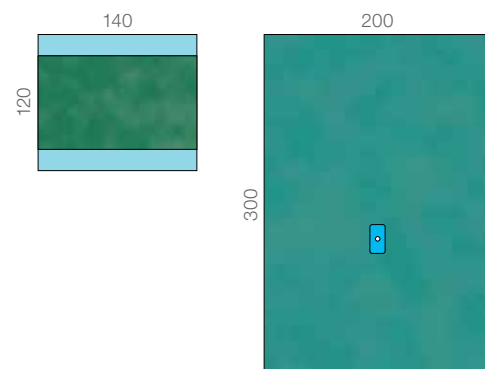

Raucodrape® Arthroscopy Drapes

Orthopaedics/Traumatology

Raucodrape® PRO Arthroscopy Set I

sterile

Contents	Size (cm)	REF	Shipping units (Pieces)
1 wrapping paper	80 x 100	33 350	23
1 instrument table cover Lite	80 x 145		
1 stockinette, short	24 x 80		
1 adhesive film strip	10 x 50		
1 adhesive strip	9 x 50		
1 extremity drape, 2-layered, with elastic fenestration	200 x 300		
	7		

Multi-sheet set incl. an extremity drape with an elastic cuff for minimally invasive and other surgical procedures on the limbs.

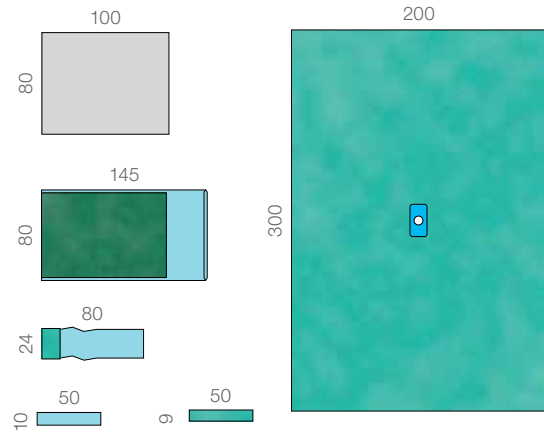

Raucodrape® PRO Arthroscopy Set II

sterile

Contents	Size (cm)	REF	Shipping units (Pieces)
1 wrapping paper	80 x 100	33 351	21
1 instrument table cover Lite	80 x 145		
1 camera drape, reverse-fold	13 x 250		
1 orthopaedic stockinette	33 x 55		
1 adhesive film strip	10 x 50		
1 adhesive strip	9 x 50		
1 extremity drape, 2-layered, with elastic fenestration	200 x 300		
	7		

Multi-sheet set incl. an extremity drape with an elastic cuff for minimally invasive and other surgical procedures on the limbs.

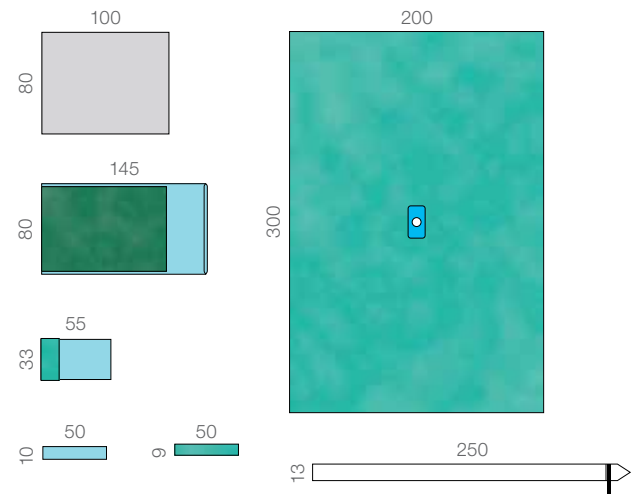

Raucodrape® SMART Arthroscopy Set

sterile

Contents	Size (cm)	REF	Shipping units (Pieces)
1 table cover	120 x 140	33 851	17
4 towles	30 x 20		
1 camera drape, reverse-fold	13 x 250		
1 orthopaedic stockinette	33 x 55		
1 adhesive film strip	10 x 50		
1 instrument table cover	80 x 145		
1 adhesive strip	9 x 50		
1 extremity drape, 2-layered, elastic fenestration	200 x 280		
	7		

Multi-sheet set incl. an extremity drape with an elastic cuff for minimally invasive and other surgical procedures on the limbs.

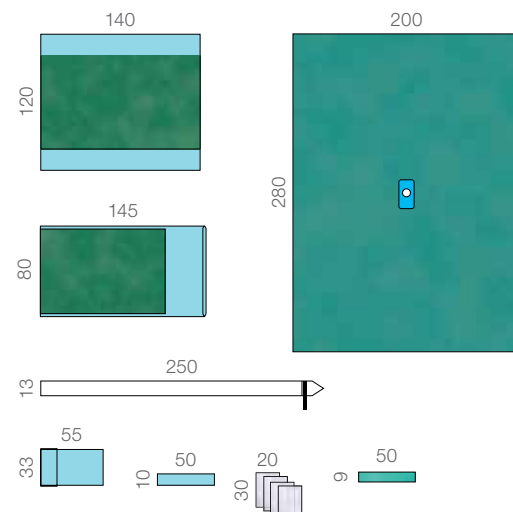

All measurements in cm

Raucodrape® PRO Arthroscopy Set III

sterile

Contents	Size (cm)	REF	Shipping units (Pieces)
1 wrapping paper	100 x 120	33 352	11
2 SMMS Surgical Gowns Standard	150		
1 instrument table cover Lite	80 x 145		
1 camera drape, reverse-fold	13 x 250		
1 orthopaedic stockinette	33 x 55		
1 adhesive film strip	10 x 50		
1 adhesive strip	9 x 50		
1 extremity drape, 2-layered, with elastic fenestration	200 x 300 7		

Multi-sheet set incl. an extremity drape with an elastic cuff for minimally invasive and other surgical procedures on the limbs.

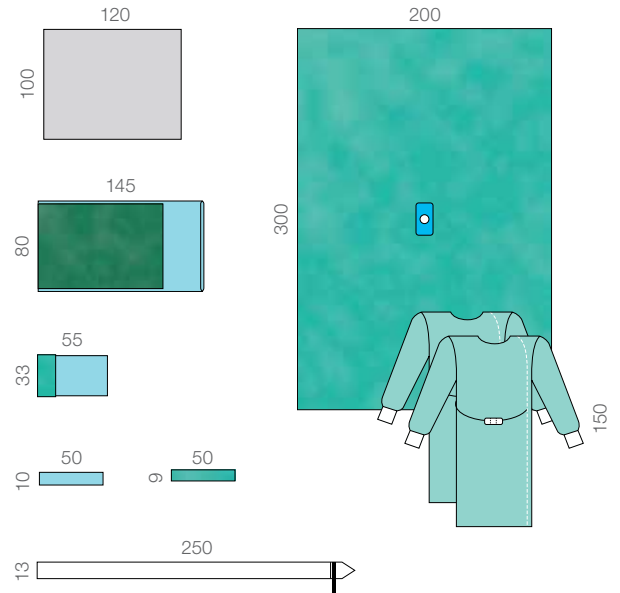

Raucodrape® PRO Arthroscopy Set IV

sterile

Contents	Size (cm)	REF	Shipping units (Pieces)
1 wrapping paper	80 x 100	33 353	15
1 SMMS Surgical Gown Standard	150		
1 instrument table cover Lite	80 x 145		
1 camera drape, reverse-fold	13 x 250		
1 orthopaedic stockinette	33 x 55		
1 adhesive film strip	10 x 50		
1 adhesive strip	9 x 50		
1 extremity drape, 2-layered, with elastic fenestration	200 x 300 7		

Multi-sheet set incl. an extremity drape with an elastic cuff for minimally invasive and other surgical procedures on the limbs.

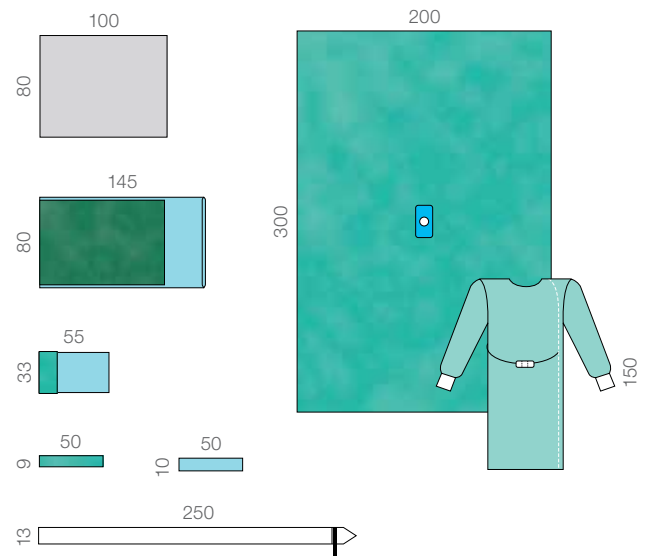

Raucodrape® PRO Shoulder Arthroscopy Set I

sterile

Contents	Size (cm)	REF	Shipping units (Pieces)
1 wrapping paper	80 x 100	33 354	20
1 instrument table cover Lite	80 x 145		
1 orthopaedic stockinette	33 x 55		
1 adhesive film strip	10 x 50		
1 split sheet, 2-layered, slit	225 x 260 10 x 100		

Multi-sheet set for minimally invasive and other surgical procedures, particularly suited for surgical procedures on the shoulder.

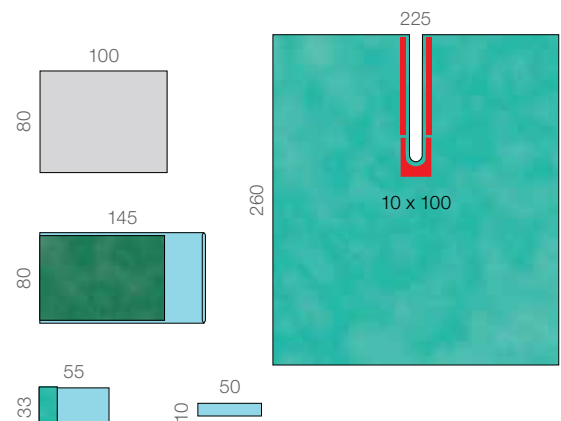

__ indicates the side with the adhesive area

All measurements in cm

Raucodrape® Arthroscopy Drapes

Orthopaedics/Traumatology

Raucodrape® PRO

Knee Arthroscopy Set

sterile

Contents	Size (cm)	REF	Shipping units (Pieces)
1 table cover	150 x 190	33 348	10
2 towels	30 x 40		
1 instrument table cover	80 x 145		
1 OR drape sheet, 2-layered	150 x 180		
1 orthopaedic stockinette	33 x 55		
1 adhesive film strip	10 x 50		
1 knee arthroscopy drape, with elastic fenestrations, with integrated fluid collection pouch incl. drainage port, with integrated tube retainers and hook-and-loop fastener	225 x 320 6 + 7		

Multi-sheet patient drape incl. knee arthroscopy drape with an elastic cuff for minimally invasive and other surgical procedures on the knee joint.

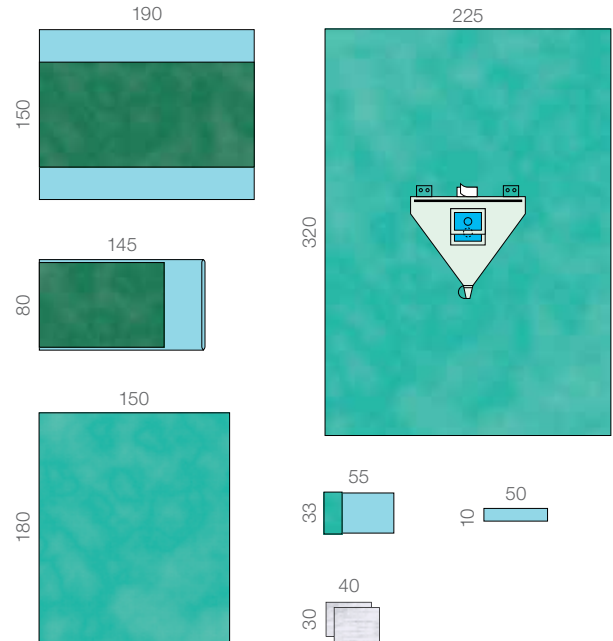

Raucodrape® PRO

Knee Arthroscopy Drape

sterile

Contents	Size (cm)	REF	Shipping units (Pieces)
knee arthroscopy drape, with elastic fenestrations, with integrated fluid collection pouch incl. drainage port, with integrated tube retainers and hook-and-loop fastener	225 x 320 6 + 7	33 086	11/22

Knee arthroscopy drape with elastic cuff. For minimally invasive and other surgical procedures on the knee joint with the patient in a supine position and the lower section of the leg rest either up or down.

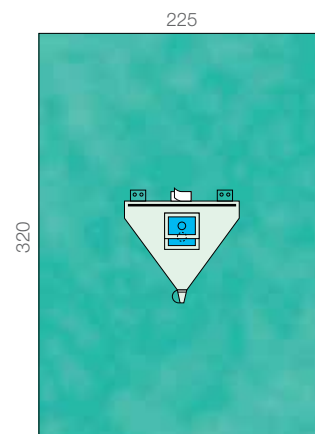

Raucodrape® PRO

Shoulder Arthroscopy Set, Beach Chair

sterile

Contents	Size (cm)	REF	Shipping units (Pieces)
1 table cover	150 x 190	33 355	14
2 towels	30 x 40		
1 instrument table cover	80 x 145		
1 adhesive film strip	10 x 50		
1 stockinette, short	24 x 80		
1 shoulder arthroscopy drape, with elastic, pear-shaped fenestration, with integrated fluid collection pouch incl. drainage port, with three hook-and-loop fasteners	225 x 380 11.5 x 12.5		

Multi-sheet patient drape for minimally invasive and other surgical procedures on the shoulder with the patient in the beach-chair position.

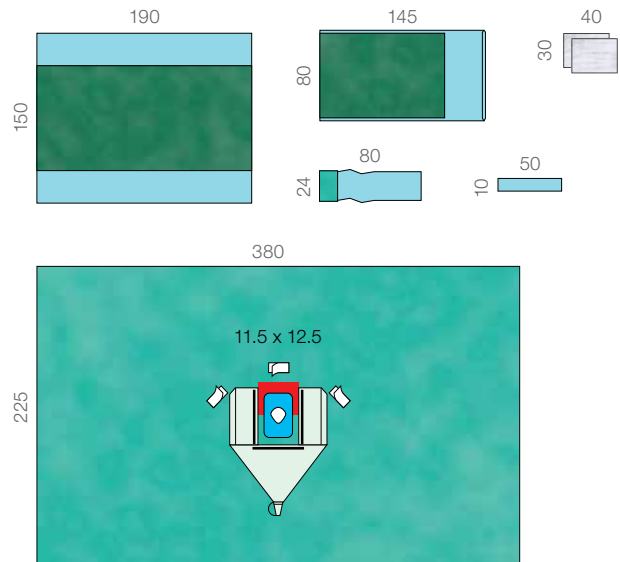

Raucodrape®

Vertical Drape/Vertical Drape Set

Orthopaedics/Traumatology

Raucodrape® PRO Vertical Drape Set

sterile

Contents	Size (cm)	REF	Shipping units (Pieces)
1 table cover	150 x 190	33 389	10
2 towels	30 x 40		
1 instrument table cover	80 x 145		
1 vertical drape, transparent PE film, with integrated surgical incision film, with integrated fluid collection pouch incl. sieve and drainage port, with two diathermy pouches, with two hook-and-loop fasteners for retaining tubes and cords	250 x 330 80 x 30		

Vertical drape made from transparent film for surgical procedures on an extension table.

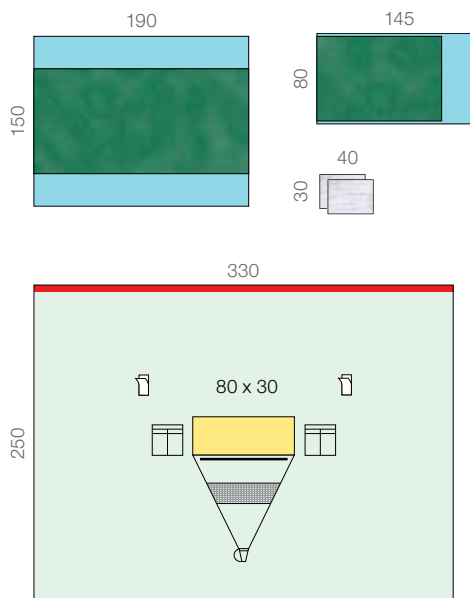

Raucodrape® PRO Vertical Drape

sterile

Contents	Size (cm)	REF	Shipping units (Pieces)
vertical drape, transparent PE film, with integrated surgical incision film, with integrated fluid collection pouch incl. sieve and drainage port, with two diathermy pouches, with two hook-and-loop fasteners for retaining tubes and cords	250 x 330 80 x 30	137 038	15

Vertical drape made from transparent film for surgical procedures on an extension table.

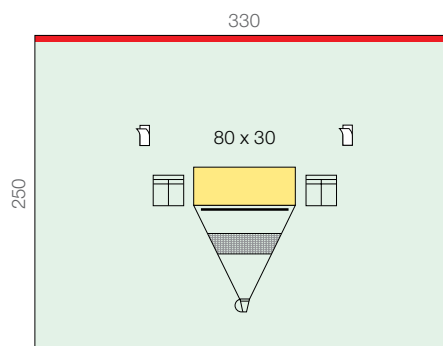

Raucodrape® SMART Vertical Drape

sterile

Contents	Size (cm)	REF	Shipping units (Pieces)
1 wrapping paper	90 x 100	33 738	20
4 towels	30 x 40		
1 vertical drape, transparent PE film, with integrated surgical incision film, with integrated fluid collection pouch incl. sieve and drainage port, with two tube retainers for retaining tubes and cords	230 x 320 30 x 40		
1 Instrument pouch	20 x 30		

Vertical drape made from transparent film for surgical procedures on an extension table.

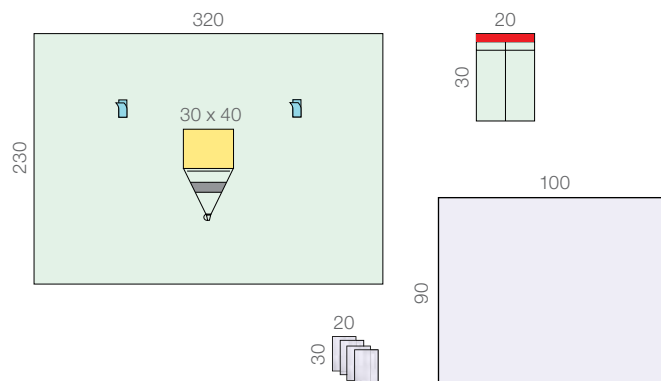

— indicates the side with the adhesive area

All measurements in cm

Neurosurgery, ENT, CMF, Ophthalmology



Raucodrape® Cranio Set

Neurosurgery, ENT, CMF, Ophthalmology

Raucodrape® PRO Cranio Set

sterile

Contents	Size (cm)	REF	Shipping units (Pieces)
1 table cover	150 x 190	33 370	14
2 towels	30 x 40		
1 instrument table cover	80 x 145		
3 adhesive drapes, PE film	50 x 50		
1 craniotomy drape, fenestration, with integrated surgical incision film, with integrated fluid collection pouch, with lateral gutters incl. sieve and drainage port, with integrated tube retainers	225 x 280 19 x 25		

Multi-sheet patient drape including craniotomy drape with reinforcement above the operating field with lateral gutters for surgical procedures on the skull.

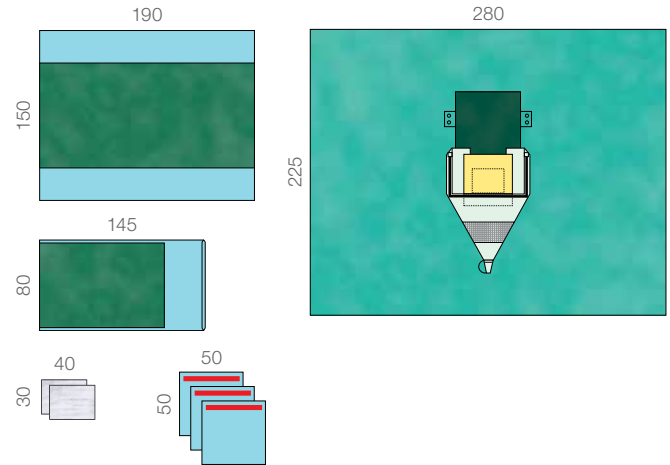

Raucodrape® LAP/Spinal Drape

Neurosurgery, ENT, CMF, Ophthalmology

Raucodrape® PRO LAP/Spinal Drape

sterile, 3-layered

Contents	Size (cm)	REF	Shipping units (Pieces)
LAP/spinal drape, 3-layered, fenestration, oval, lengthwise, off-centre, self-adhesive	225 x 320 11 x 22	33 051	8/16

All-in-one drape for surgical procedures on the abdomen and back.

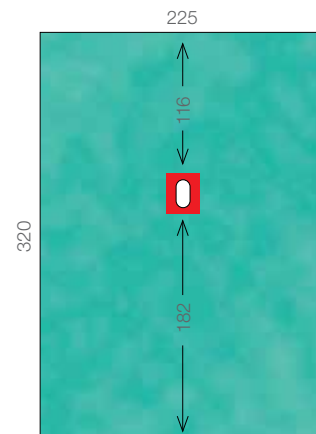

Raucodrape® Head Sets

Neurosurgery, ENT, CMF, Ophthalmology

Raucodrape® PRO Head Set I

sterile

Contents	Size (cm)	REF	Shipping units (Pieces)
1 table cover	150 x 190	33 371	16
4 towels	30 x 40		
1 instrument table cover	80 x 145		
1 OR drape sheet, 2-layered	75 x 90		
1 split sheet, 2-layered, slit	150 x 250 10 x 80		
1 adhesive drape, 2-layered	75 x 90		

Two-sheet drape for surgical procedures on the head and the throat/neck area.

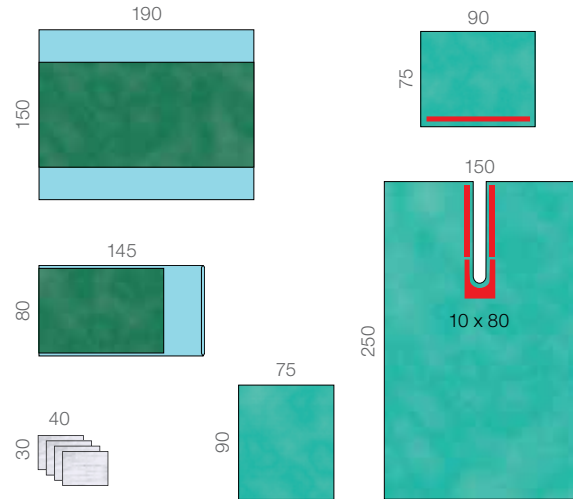

Raucodrape® PRO Head Set II

sterile

Contents	Size (cm)	REF	Shipping units (Pieces)
1 table cover	150 x 190	139 937	13
4 towels	30 x 40		
1 instrument table cover	80 x 145		
1 adhesive strip	9 x 50		
1 turban drape, 2-part, 3-layered/2-layered	130 x 100		
1 split sheet, 2-layered Plus, slit rectangular, with integrated tube retainers	225 x 300 14 x 80		

Two-sheet drape for surgical procedures on the head and the throat/neck area.

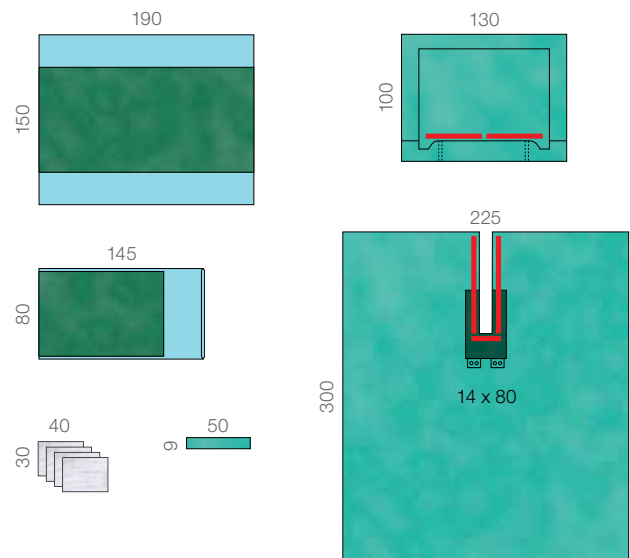

Raucodrape® Split Sheet / Split Sheet Set

Neurosurgery, ENT, CMF, Ophthalmology

Raucodrape® PRO

Variable Split Sheet Set

sterile

Contents	Size (cm)	REF	Shipping units (Pieces)
1 table cover	150 x 190	33 313	15
4 towels	30 x 40		
1 instrument table cover	80 x 145		
1 split sheet, 2-layered Plus, slit	225 x 240 20 x 20		
1 split sheet, 2-layered, slit	150 x 260 20 x 65		

Two-sheet drape for interdisciplinary surgical procedures in the neck area such as on the thyroid, the carotid arteries, the cervical spine and for pacemaker implantation.

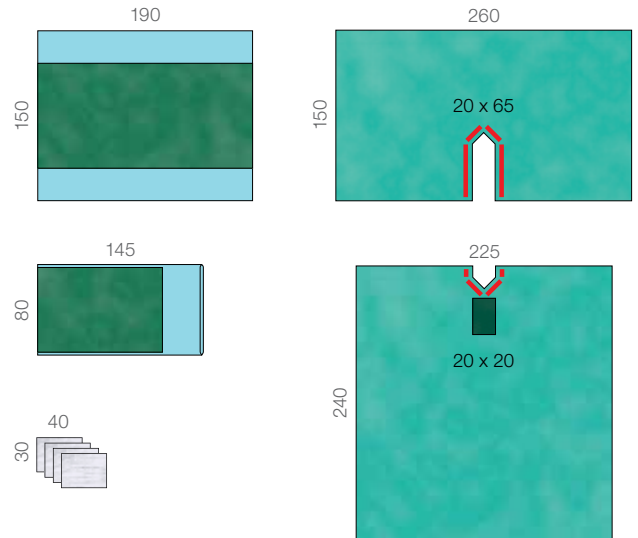

Raucodrape® PRO OR Split Sheet

sterile

Contents	Size (cm)	REF	Shipping units (Pieces)
2-layered			
split sheet, 2-layered, slit	150 x 250 10 x 80	33 073	14/28

Split-sheet for surgical procedures; particularly appropriate for face and neck/throat surgeries.

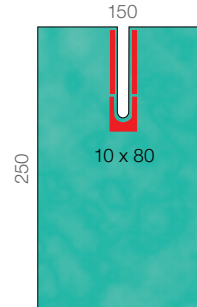

Raucodrape® Fenestrated Drapes

Neurosurgery, ENT, CMF, Ophthalmology

Raucodrape® PRO Fenestrated Ear Drape

sterile

Contents	Size (cm)	REF	Shipping units (Pieces)
fenestrated ear drape, 2-layered,	175 x 240	33 050	11/22
fenestration, oval, lengthwise, off-centre	5 x 7.5		

All-in-one drape, e.g. for procedures on the ear.

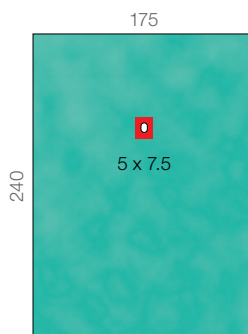

Raucodrape® PRO CMF Drape

sterile

Contents	Size (cm)	REF	Shipping unit (pcs.)
1 wrapping paper	75 x 90	33 045	18 / 36
1 CMF drape, 2-layered, rhomboid fenestration, off-centre	112 x 150 10 x 14		

All-in-one drape with anatomical, non-adhesive fenestration for oral and maxillofacial, ENT and dental surgical procedures, such as dental extractions, dental implants, cyst treatment and apioectomy, as well as for minor procedures in the ENT region.

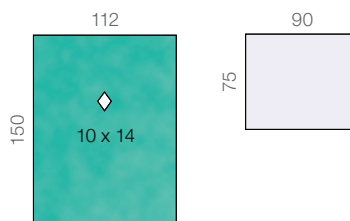

Raucodrape® Eye Drapes

Neurosurgery, ENT, CMF, Ophthalmology

Raucodrape® PRO Eye Drape

sterile

Contents	Size (cm)	REF	Shipping units (Pieces)
eye drape, 2-layered, fenestration in the middle, centred, with perforated elastic adhesive film	80 x 80 7 x 10	33 077	30/120

All-in-one drape can be used on either eye for ophthalmological procedures and for intravitreal injections.

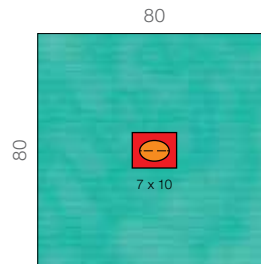

Raucodrape® PRO Eye Drape

non-sterile, available for individual sets only

Contents	Size (cm)	Component No. Individual Sets
eye drape, 2-layered, fenestration, oval, off-centre, with integrated fluid collection pouches on both sides	120 x 150 7 x 10	2 075 963
eye drape, 2-layered, fenestration, oval, centred, with perforated elastic adhesive film	50 x 50 7 x 10	2 063 052

All-in-one drape can be used for ophthalmology procedures on either eye, e.g. cataract surgeries.

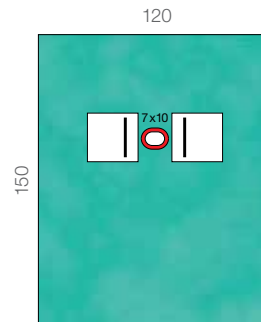

Component No.
2 075 963

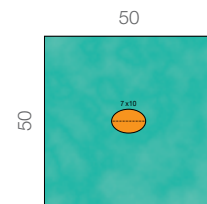

Component No.
2 063 052

Raucodrape® SMART Eye Drape

non-sterile, available for individual sets only

Contents	Size (cm)	Component No. Individual Sets
eye drape, 2-layered, circular fenestration, centred, with elastic adhesive film, with integrated fluid collection pouch	115 x 134 7.5	2 078 696
eye drape, 2-layered, fenestration, oval, off-centre, with perforated elastic adhesive film, with integrated fluid collection pouch	60 x 57.5 6 x 8	2 073 671

All-in-one drape can be used for ophthalmology procedures on either eye, e.g. cataract surgeries.

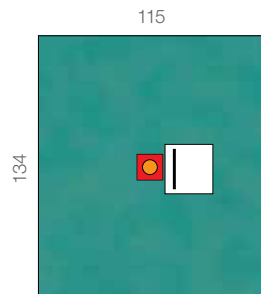

Component No.
2 078 696

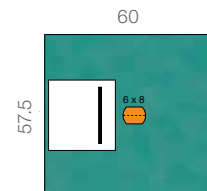

Component No.
2 073 671

Raucodrape® PRO Eye Drape

sterile

Contents	Size (cm)	REF	Shipping units (Pieces)
eye drape, 3-layered	150 x 150	160 056	16/32
fenestration in the middle, centred,	7 x 10		
with continuous elastic adhesive film,			
with integrated fluid collection pouch			

All-in-one drape can be used for ophthalmology procedures on either eye, e.g. cataract surgeries.

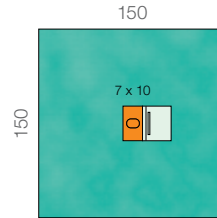

Raucodrape® PRO Eye Drape

non-sterile, available for individual sets only

Contents	Size (cm)	Component No. Individual Sets
eye drape, 3-layered	150 x 160	2 110 183
fenestration, oval, centred,	7 x 10	
with perforated elastic adhesive film, with integrated fluid collection pouch		
eye drape, 3-layered	120 x 160	2 110 182
fenestration, oval, off-centre,	7 x 10	
with perforated elastic adhesive film, with integrated fluid collection pouches on both sides,		
with nose clip		

All-in-one drape can be used for ophthalmology procedures on either eye, e.g. cataract surgeries.

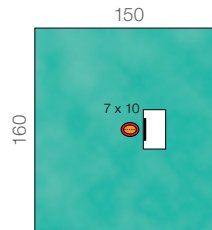

Component No.
2 110 183

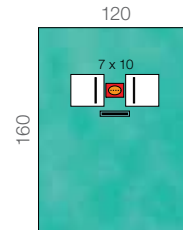

Component No.
2 110 182

Cardiovascular Surgery/Angiography



Raucodrape® Cardiovascular Set

Cardiovascular Surgery/Angiography

Raucodrape® PRO Cardiovascular Set

sterile

Contents	Size (cm)	REF	Shipping units (Pieces)
1 table cover	150 x 190	33 383	8
4 towels	30 x 40		
2 instrument table covers	80 x 145		
2 adhesive strips	9 x 50		
2 foot protectors, transparent	40 x 27,5		
1 OR Drape Sheet	150 x 180		
1 split sheet bilateral, 2-layered Plus, slit, with integrated tube retainer	175 x 260 20 x 100		
1 cardiovascular drape, 2-layered Plus, fenestration, with integrated surgical incision film, with 2-chamber diathermy pouches on both sides, with two additional 1-chamber diathermy pouches, with five hook-and-loop fasteners for retaining tubes and cords	300/225 x 370 38 x 40		

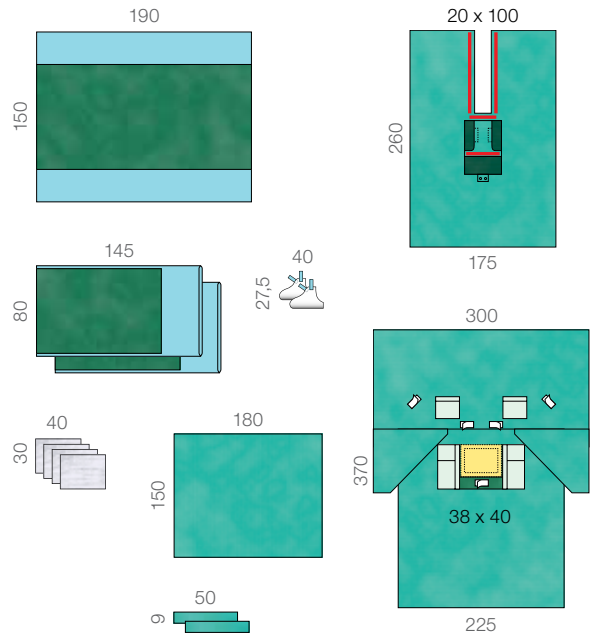

Multi-sheet patient drape for procedures in cardiac surgery such as a bypass.

Raucodrape® PRO Hybrid Set

sterile

Contents	Size (cm)	REF	Shipping units (Pieces)
1 table cover	150 x 190	145 384	8
4 towels	30 x 40		
1 Instrument table cover Special	80 x 145		
2 adhesive strips	9 x 50		
2 adhesive drapes, 2-layered	75 x 90		
1 hybrid drape, 2-layered Plus, with transparent film on both sides, with thoracic fenestration, with integrated incise film, two femoral fenestrations, with integrated incise film, with 2-chamber diathermy pouches on both sides, with armrest cover	235/330 x 450 60 x 40 15 x 27		

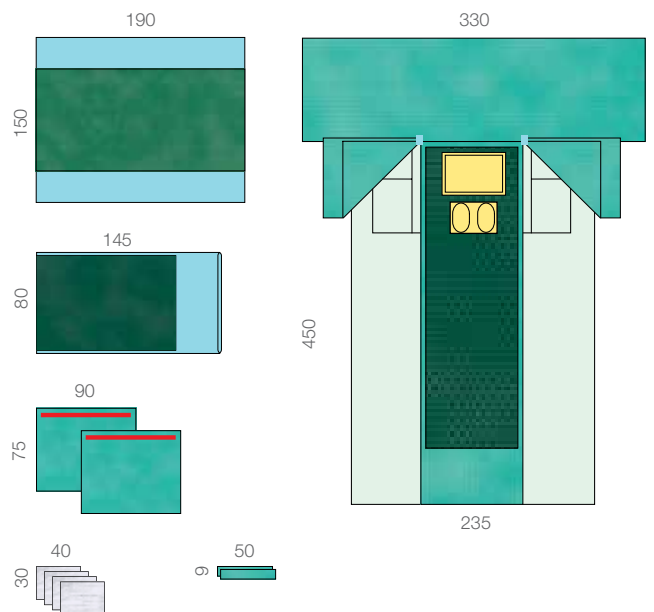

All-In-One Drape for hybrid procedures such as TAVI.

__ indicates the side with the adhesive area

All measurements in cm

Raucodrape® Angiography Drapes

Cardiovascular Surgery/Angiography

Raucodrape® PRO Angiography Drape I

sterile

Contents	Size (cm)	REF	Shipping units (Pieces)
1 wrapping paper	80 x 100	33 381	11/22
1 towel	30 x 40		
1 adhesive strip	9 x 25		
1 angiography drape, 3-layered, with two fenestrations, circular, off-centre	150 x 240 12		

All-in-one drape for angiography procedures.

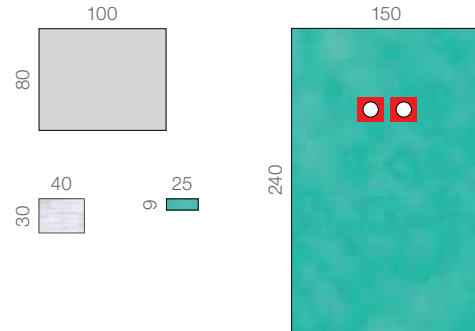

Raucodrape® PRO Angiography Drape II

sterile

Contents	Size (cm)	REF	Shipping units (Pieces)
1 wrapping paper	80 x 100	33 382	8/16
1 towel	30 x 40		
1 adhesive strip	9 x 25		
1 angiography drape, 3-layered, with reinforcement around the operating field, with PE film on both sides, with two fenestrations, off-centre, with elastic adhesive film incl. fenestration	227 x 330 12 x 12 8		

All-in-one drape with reinforcement around two off-centre fenestrations, with a large film on both sides for covering patients and control panels for angiography procedures.

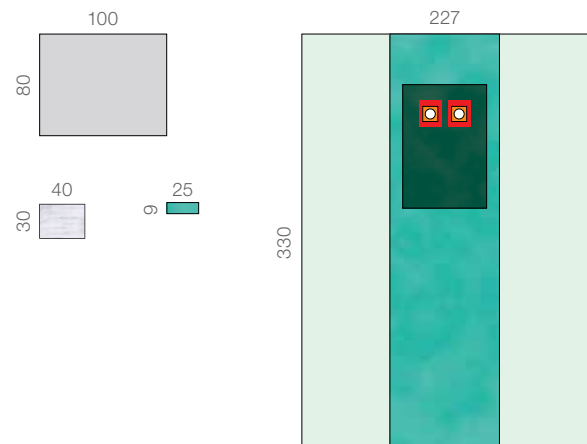

Raucodrape® PRO Angiography Drape III

non-sterile, available for individual sets only

Contents	Size (cm)	Component No. Individual sets
angiography drape, 2-layered Plus, with PE film on both sides,	240 x 335	3 014 694
two femoral fenestrations, off-centre	7 x 9	
two radial fenestrations, off-centre	5 x 7	

All-in-one drape with reinforcement and two femoral and radial fenestrations

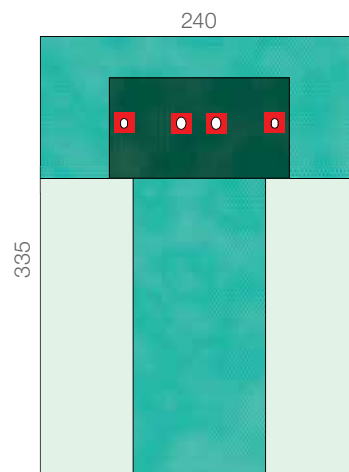

Drapes and Accessories



Raucodrape® Drape Sheets

Drapes and Accessories

Raucodrape® Drape Sheets

sterile, 2-layered

Size (cm)	REF	Shipping units (Pieces)
38 x 45	33 001	220/880
45 x 75	33 002	120/480
75 x 90	33 003	65/260

Fluid-impermeable drape with good draping behaviour for use in an outpatient setting or on inpatient wards. 2-layered material of tear-resistant polyethylene film and absorbent polypropylene nonwoven fabric.

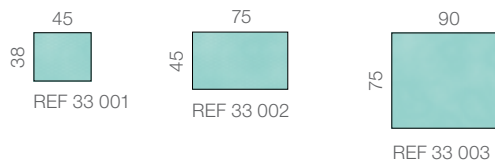

Raucodrape® PRO OR Drape Sheets

sterile, 2-layered

Size (cm)	REF	Shipping units (Pieces)
75 x 90	33 005	40/160
90 x 110	33 190	25/100
100 x 150	33 008	27/54
150 x 180	33 009	13/26
150 x 240	33 004	13/26

Fluid-impermeable drapes with good draping behaviour made of tear-resistant polyethylene film and absorbent polypropylene nonwoven fabric. For covering patients and equipment in the OR or in an outpatient setting.

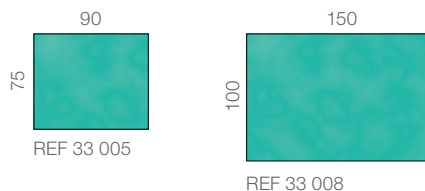

Raucodrape® SMART OR Drape Sheets

sterile, 2-layered

Size (cm)	REF	Shipping units (Pieces)
75 x 75	153 704	50
75 x 90	153 705	46
100 x 100	153 706	48
150 x 150	33 707	40

Fluid-impermeable drapes with good draping behaviour made of tear-resistant polyethylene film and absorbent polypropylene nonwoven fabric. For covering patients and equipment in the OR or in an outpatient setting.

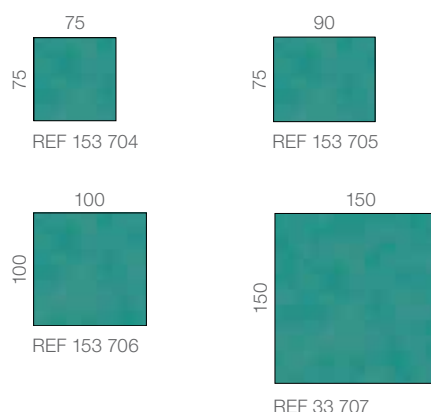

Raucodrape® OR Table Covers

Drapes and Accessories

Raucodrape® OR Table Covers

sterile

Size (cm)	REF	Shipping units (Pieces)
OR table cover Standard		
120 x 140	33 090	26/52
150 x 190	33 091	15/30
OR table cover special		
150 x 190	33 092	11/22
OR table cover special XL		
200 x 250	34 096	7/14
instrument table cover Standard		
80 x 145	33 093	35/70
instrument table cover Lite		
80 x 145	33 094	40/80
instrument table cover Special		
80 x 145	33 095	25/50

Fluid-impermeable and extremely tear-resistant OR table cover with an absorbent nonwoven layer suitable for all side and instrument tables.

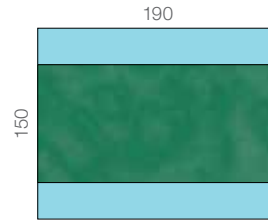

REF 33 091



REF 33 095



REF 33 092

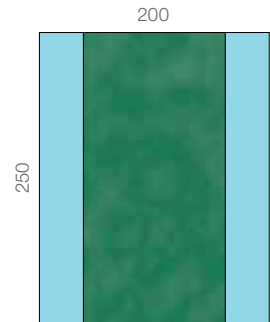

REF 34 096

Raucodrape® OR Adhesive Drapes

Drapes and Accessories

Raucodrape® PRO OR Adhesive Drapes

sterile

Size (cm)	REF	Shipping units (Pieces)
2-layered		
50 x 50	33 010	80/320
50 x 75	33 011	60/240
75 x 75	33 012	40/160
75 x 90	33 013	38/152
90 x 110	33 020	25/100
150 x 180	33 025	20/40
175 x 180	33 016	17/34
150 x 240	33 018	15/30
175 x 300	33 024	10/20
2-layered Plus		
150 x 180	33 015	18/36
175 x 180	33 017	15/30
150 x 250	33 019	14/28
190 x 225	33 021	11/22
175 x 300	141 524	9/18
instrument collection drape, 2-layered		
90 x 150	33 022	19/76

Fluid-impermeable, self-adhesive drapes with good draping behaviour for easy and safe application on patients and for outlining the operating field.

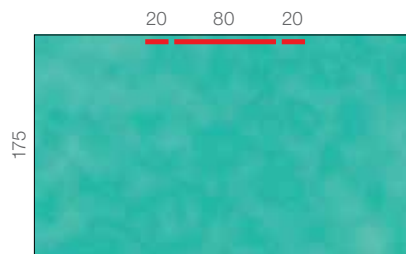

REF 33 024 300

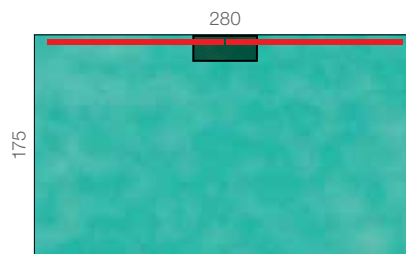

REF 141 524 300

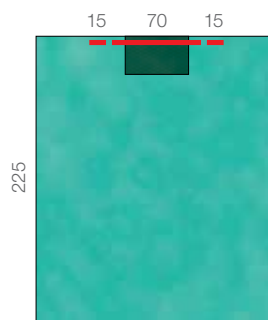

REF 33 021 190

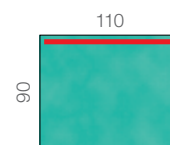

REF 33 020

Raucodrape® SMART OR Adhesive Drapes

sterile, 2-layered

Size (cm)	REF	Shipping units (Pieces)
75 x 90	33 716	120
175 x 170	33 718	30
140 x 240	33 717	28

Fluid-impermeable, self-adhesive drapes with good draping behaviour for easy and safe application on patients and for outlining the operating field.

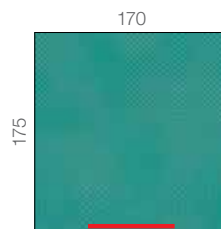

REF 33 718 80



REF 33 717 80

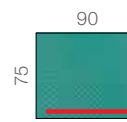

REF 33 716 76

Raucodrape® Fenestrated Drapes

Drapes and Accessories

Raucodrape® Fenestrated Drapes

sterile

Size/Position Fenestration	Size (cm)	REF	Shipping units (Pieces)
6 cm, circular, centred	45 x 75	33 040	130/520
8 cm, circular, centred	75 x 90	33 042	70/280

Fluid-impermeable, partly self-adhesive drape with good draping behaviour, with fenestrations of different sizes.

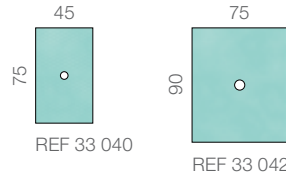

Raucodrape® OR Fenestrated Drapes

sterile

Size/Position Fenestration	Size (cm)	REF	Shipping units (Pieces)
epidural drape, transparent, self-adhesive			
10 cm, circular, centred	75 x 100	33 148	55/220
epidural drape, 2-layered, self-adhesive			
10 cm, circular, off-centre	60 x 75	33 047	68/272

Fluid-impermeable, partly self-adhesive drape with good draping behaviour, with fenestrations of different sizes.

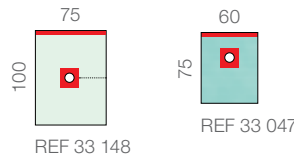

Raucodrape® Interventional Puncture Drape

non-sterile, available for individual sets only

Contents	Size (cm)	Component No. Individual Sets
Interventional Puncture Drape, 2-layer, with perforated PE film, fenestration, round, off-centre, self-adhesive	100 x 150	2 050 288
	10	

Fluid-impermeable, partly self-adhesive drape with good draping behaviour, with fenestrations of different sizes.

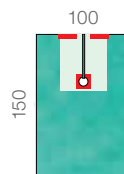

Raucodrape® Fenestrated Drapes

Drapes and Accessories

Raucodrape® PRO OR Fenestrated Drapes

sterile, 2-layered, self-adhesive

Size/Position Fenestration	Size (cm)	REF	Shipping units (Pieces)
variable	50 x 75	33 058	50/200
variable	75 x 90	33 059	30/120
6 cm, circular, centred	50 x 60	33 041	70/280
8 cm, circular, centred	75 x 90	33 043	40/160
7 x 10 cm, oval, landscape format, off-centre	120 x 150	33 044	25/50
12 cm, circular, off-centre	150 x 200	33 046	18/36

Fluid-impermeable, partly self-adhesive drape with good draping behaviour, with fenestrations of different sizes.

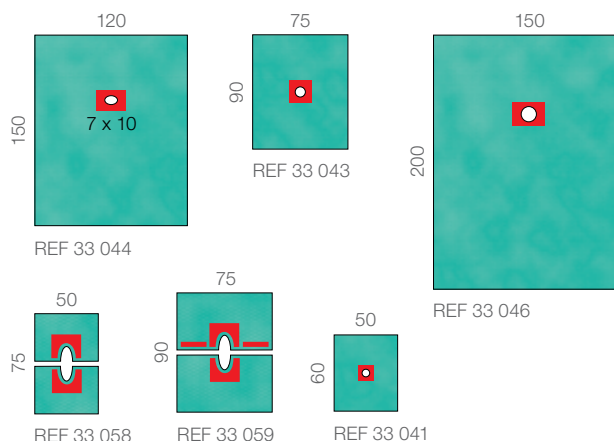

Raucodrape® SMART OR Fenestrated Drapes

sterile, 2-layered, self-adhesive

Size/Position Fenestration	Size (cm)	REF	Shipping units (Pieces)
variable	75 x 90	153 742	40
6 cm, circular, centred	50 x 60	153 740	70
7 x 10 cm, oval, landscape format, off-centre	120 x 150	33 741	50

Fluid-impermeable, partly self-adhesive drape with good draping behaviour, with fenestrations of different sizes.

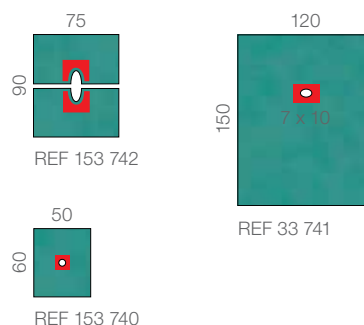

Raucodrape® PRO Epidural Drape

sterile, 2-layered, self-adhesive

Size/Position Fenestration	Size (cm)	REF	Shipping units (Pieces)
10 x 15 cm, rectangular, lengthwise, off-centre	55 x 90	33 049	45/180

Fluid-impermeable, partly self-adhesive drape with good draping behaviour, with fenestrations of different sizes.



Raucodrape® PRO CMF Drape

sterile, 2-layered, with wrapping paper

Size/Position Fenestration	Size (cm)	REF	Shipping units (Pieces)
10 x 14 cm, rhomboid, off-centre	112 x 150	33 045	18/36

All-in-one drape with anatomical, non-adhesive fenestration for oral and maxillofacial, ENT and dental surgical procedures, such as dental extractions, dental implants, cyst treatment and apicoectomy, as well as for minor procedures in the ENT region.

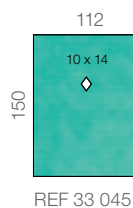

— indicates the side with the adhesive area

All measurements in cm

Raucodrape® PRO Fenestrated Ear Drape

sterile, 2-layered, self-adhesive

Size/Position Fenestration	Size (cm)	REF	Shipping units (Pieces)
5 x 7.5 cm, oval, lengthwise, off-centre	175 x 240	33 050	11/22

All-in-one drape, e.g. for procedures on the ear.

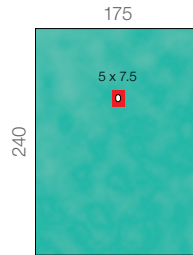

Raucodrape® PRO Fenestrated drape with surgical incision film

sterile, 2-layered, with surgical incision film

Size/Position Fenestration	Size (cm)	REF	Shipping units (Pieces)
7 x 10 cm, oval, lengthwise, centred	120 x 150	33 055	22/44

Fenestrated drape for interdisciplinary surgical procedures.

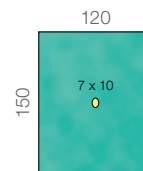

Raucodrape® PRO LAP/Spinal Drape

sterile, 3-layered

Size/Position Fenestration	Size (cm)	REF	Shipping units (Pieces)
11 x 22 cm, oval, lengthwise, off-centre, self-adhesive	225 x 320	33 051	8/16

All-in-one drape for surgical procedures on the abdomen and back.

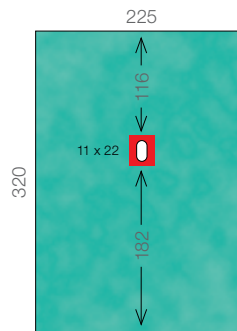

Raucodrape® Split Sheets Drapes and Accessories

Raucodrape® PRO OR Split Sheets

sterile

Size (cm)	Slit Size (cm)	REF	Shipping units (Pieces)
2-layered			
75 x 90	7 x 30	33 062	35/140
125 x 150	10 x 45	33 064	28/56
150 x 200	10 x 65	33 067	14/28
150 x 250	10 x 80	33 073	14/28
225 x 260	10 x 100	33 069	13/26
3-layered			
150 x 200	10 x 65	33 068	10/20
2-layered Plus			
225 x 260	10 x 100	33 071	11/22
2-layered Plus, with integrated tube retainers			
225 x 280	10 x 100	33 060	10/20
bilateral, 2-layered Plus, with integrated tube retainers			
175 x 260	20 x 100	33 072	13/26

Fluid-impermeable drapes with good draping behaviour, a U-shaped fenestration and a three-piece adhesive strip for easy and safe application to the patient; for procedures on the limbs, shoulder, neck/throat and head.

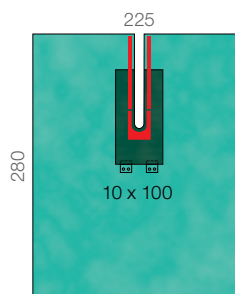

REF 33 060

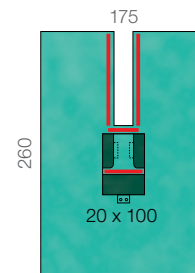

REF 33 072

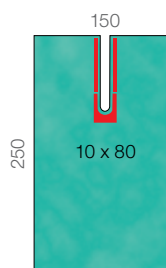

REF 33 073

Raucodrape® SMART OR Split Sheet

sterile, 2-layered

Contents	Size (cm)	REF	Shipping units (Pieces)
split sheet, 2-layered, slit	200 x 260 10 x 80	33 760	18

Fluid-impermeable drapes with good draping behaviour, a U-shaped fenestration and a three-piece adhesive strip for easy and safe application to the patient; for procedures on the limbs, shoulder, neck/throat and head.

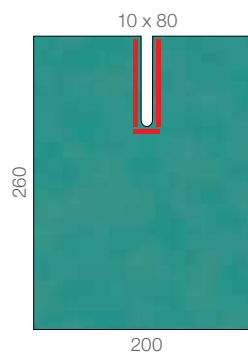

Raucodrape® Split Sheet

sterile, PE film

Size (cm)	Slit Size (cm)	REF	Shipping units (Pieces)
150 x 210	14 x 75	33 066	40/80

Fluid-impermeable drapes with good draping behaviour, a U-shaped fenestration and a three-piece adhesive strip for easy and safe application to the patient; for procedures on the limbs, shoulder, neck/throat and head.

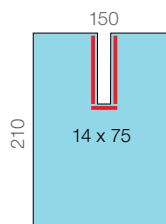

Raucodrape® Equipment Covers

Drapes and Accessories

Raucodrape® Equipment Covers

sterile

Contents	Size (cm)	REF	Shipping units (Pieces)
Chair cover	Ø = 75	33 124	30/120
Control panel cover, circular	80 x 90	33 113	40/160
Control panel cover, circular	Ø = 90	33 120	20/80
Control panel cover, circular	Ø = 120	33 121	15/60
Control panel cover, rectangular	80 x 145	33 112	25/100
Control panel cover, rectangular	80 x 45	33 122	30/120
Image converter set, three-piece			
2 image converter covers	65 x 75	33 155	20/40
1 C-arm cover	30 x 195		
Image converter set, one-piece	90 x 225	33 115	19/38
Camera drape, telescopically folded	13 x 250	138 965	55/220
Camera drape, reverse-fold	13 x 250	138 966	70/280
Camera drape with ring	15 x 250	33 119	20/80
Camera drape	16 x 250	138 128	62/124
Armrest covers, 2 pieces	35 x 73	33 123	46/184

For all conventional image converters as well as cameras and other equipment in the OR.

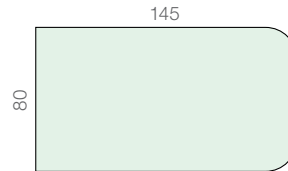

control panel cover, rectangular
REF 33 112

Raucodrape® Equipment Cover

non-sterile, available for individual sets only

Contents	Size (cm)	Component No. Individual Sets
Chair Cover, rectangular	65 x 65	3 010 999

For all conventional Chairs in the OR.

Raucodrape® Accessories

Drapes and Accessories

Raucodrape® Accessories

sterile

Contents	Size (cm)	REF	Shipping units (Pieces)
self-adhesive additional components for fast and reliable application			
Absorption pads, 2 pieces	35 x 50	33 125	80/320
Absorption pad	50 x 75	33 126	33/132
Adhesive strip	9 x 50	160 116	200/800
Hook-and-loop fastener	2.5 x 20/24	33 127	100/400
Tube retainer, self-adhesive, with retention straps	9 x 11 30	160 147	220/880
Diathermy pouch, 1 chamber	38 x 40	33 109	110/440
Diathermy pouch, 2 chambers	38 x 40	33 110	110/440
Perineal drape	20 x 40	33 100	140/560
Fluid collection pouch Universal	60 x 90	33 775	35/70
Instrument pouch, 2 chambers	45 x 25	33 156	120/480
for adding on to OR clothing and covering patients			
Sleeve protector	50	33 103	45/180
Leg protector, 2 pieces	50 x 110	33 104	26/104
Leg protector, 2 pieces	75 x 120	33 105	30/60
Stockinette, short, incl. 1 adhesive film strip	24 x 80 10 x 50	33 128	17/68
Stockinette, medium, incl. 1 adhesive film strip	24 x 110 10 x 50	33 129	12/48
Stockinette, large, incl. 2 adhesive film strips	32 x 120 10 x 50	33 130	16/32
Towels, 2 pieces	30 x 40	33 108	120/480
Under buttocks drape I	75 x 100	138 101	30/120
Under buttocks drape II with collection pouch	75 x 100	33 102	35/70

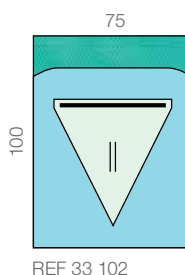
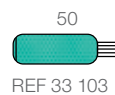
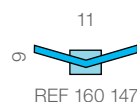
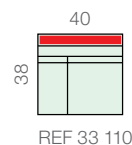
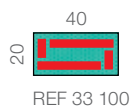

Raucodrape® Foot protectors, transparent

non-sterile, available for individual sets only

Contents	Size (cm)	Component No. Individual Sets
Foot protectors, transparent	40 x 27,5	3 021 047



Raucodrape® Baby Drape

sterile

Contents	Size (cm)	REF	Shipping units (Pieces)
Baby drape, fluid-absorbent nonwoven material	90 x 100	33 160	18/72

Fluid-absorbent, soft baby drape for receiving an infant.

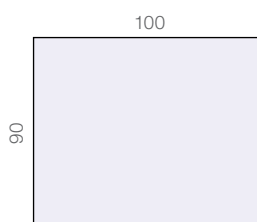

Raucodrape® PRO Accessories

sterile

Contents	Size (cm)	REF	Shipping units (Pieces)
Orthopaedic stockinette, incl. 1 adhesive film strip	33 x 55 10 x 50	33 106	65/130
Orthopaedic stockinette, incl. 2 adhesive film strips	33 x 110 10 x 50	33 107	38/76

For adding on to OR clothing and covering patients.

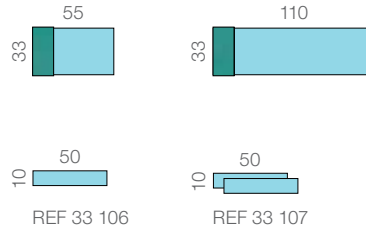

Raucodrape® SMART Accessories

sterile

Contents	Size (cm)	REF	Shipping units (Pieces)
Orthopaedic stockinette, incl. 1 adhesive film strip	33 x 55 10 x 50	153 770	104
Orthopaedic stockinette, incl. 2 adhesive film strips	33 x 110 10 x 50	153 771	68

For adding on to OR clothing and covering patients.

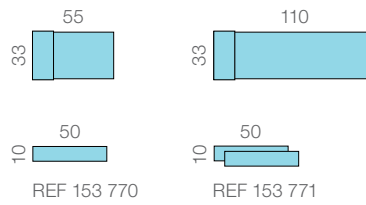

Raucodrape® Surgical Incise Drape



Field of application

used to cover the incision area during surgical procedures

Properties

- skin-friendly adhesive
- elastic and supple
- bacteria-proof
- permeable to water vapour
- transparent and glare-free
- with holding edges for user-friendly application
- use of raw materials that are not made with natural rubber latex

Product composition

Polyurethane film coated with polyacrylate adhesive

Raucodrape® Surgical Incise Drape

sterile, individually sealed

Adhesive area (cm)	REF	Shipping units (Pieces)
12 x 17	146 440	10/80
15 x 20	146 441	10/80
30 x 20	146 442	10/80
45 x 20	146 443	10/80
40 x 35	146 444	10/80
45 x 50	146 445	10/80
45 x 65	146 446	10/40
55 x 80	146 447	10/40
72 x 88	146 448	10/40

OR Clothing

Scrub suits, surgical gowns, surgical face masks, surgical caps and gloves



Sentinex® Scrub Suits – single use, multiple benefits.

There are good reasons to choose Sentinex® Scrub suits

- quality of the materials is always the same*
- hygiene – new scrubs daily
- comfort – comfortable to wear
- isolating thermo jacket keeps the staff warm in the operating rooms
- breathable material, better heat exchange



Sentinex Soft scores with a divided breast pocket



* Both materials conform to the EN 13795 standard performance requirements for surgical gowns for less critical zones.



A flexible drawstring waistband ensures a custom fit.



Elastic band in the lower back area of the thermo jacket



Warming collar to protect against cold draughts in the OR

At a glance – individually combinable and a precise fit tailored to your needs.

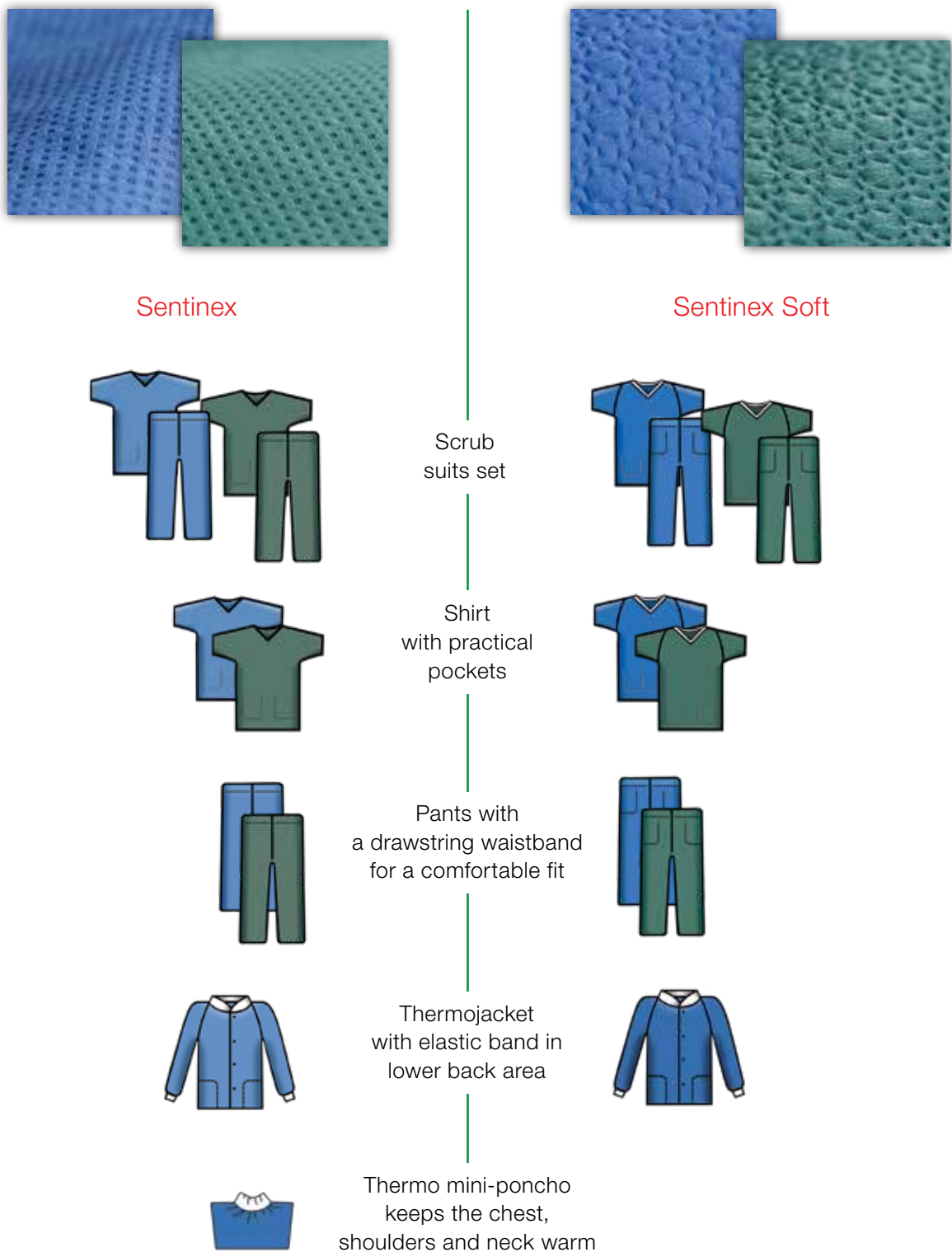

Standard sizes

Women's sizes	34	36	38	40	42	44	46	48	50	52	54
International/L&R measurements	XS	S		M		L		XL		XXL	
Men's sizes	-	44	46	48	50	52	54	56	58	60	62

Sentinex® Scrub Suits

Sentinex® Scrub Suits

Size	REF	Shipping units (Pieces)
Scrub Suit Set, green		
XS	39 501	50
S	39 514	45
M	39 515	40
L	39 516	35
XL	39 517	35
XXL	39 518	30
Scrub Suit Set, blue		
XS	39 502	50
S	39 519	45
M	39 520	40
L	39 521	35
XL	39 522	35
XXL	39 523	30
Scrub Shirt, green		
XS	39 503	105
S	39 524	100
M	39 525	90
L	39 526	80
XL	39 527	75
XXL	39 528	70
Scrub Shirt, blue		
XS	39 505	105
S	39 534	100
M	39 535	90
L	39 536	80
XL	39 537	75
XXL	39 538	70
Scrub Pants, green		
XS	39 504	80
S	39 529	75
M	39 530	70
L	39 531	65
XL	39 532	60
XXL	39 533	55
Scrub Pants, blue		
XS	39 506	80
S	39 540	75
M	39 541	70
L	39 542	65
XL	39 543	60
XXL	39 544	55
Thermojacket, blue		
M	39 512	40
L	39 513	40
Thermo Mini-Poncho, blue		
Universal size	39 580	120

Sentinex® Scrub Suits Soft

Size	REF	Shipping units (Pieces)
Scrub Suit Set Soft, green		
XS	39 507	25
S	39 545	25
M	39 546	22
L	39 547	20
XL	39 548	20
XXL	39 549	20
Scrub Suit Set Soft, blue		
XS	39 508	25
S	39 550	25
M	39 551	22
L	39 552	20
XL	39 553	20
XXL	39 554	20
Scrub Shirt Soft, green		
XS	39 509	60
S	39 555	55
M	39 556	50
L	39 557	50
XL	39 558	45
XXL	39 559	40
Scrub Shirt Soft, blue		
XS	39 576	60
S	39 565	55
M	39 566	50
L	39 567	50
XL	39 568	45
XXL	39 569	40
Scrub Pants Soft, green		
XS	39 575	50
S	39 560	45
M	39 561	40
L	39 562	40
XL	39 563	35
XXL	39 564	30
Scrub Pants Soft, blue		
XS	39 577	50
S	39 570	45
M	39 571	40
L	39 572	40
XL	39 573	35
XXL	39 574	30
Thermojacket Soft, blue		
M	39 510	30
L	39 511	30
XL	39 611	25

Sentinex[®] PRO Surgical Gowns



PRO – maximum protection for longer, more complicated procedures

- wide range of products
- generous design with very high user and wearing comfort
- exceed the EN 13795 requirements
- designed for
 - ◆ procedures such as operations with moderate to high amounts of fluid
 - ◆ and longer surgical procedures.

Two materials: Spunlace and polypropylene

Spunlace

- material with the look and feel of fabric
- outstanding wearing comfort
- skin-friendly and breathable
- also very well suited for physically demanding procedures



Polypropylene

- lighter
- reliably protect against bacteria and fluids in accordance with EN 13795 and the AAMI standard
- ensures circulation of air, heat and water vapour



Sentinex[®] PRO Surgical Gowns

Four versions: Basic, Standard, Special and Special Plus

Basic



Sentinex[®] PRO Surgical Gown Basic

Tie-back gown for minor procedures and treatments, with 3 ties on the back for reliable closure.

Standard



Sentinex[®] PRO Surgical Gown Standard

Wraparound surgical gown with sterile back section thanks to very generous overlap. Optimally suited for procedures with low amounts of fluid.

Special



Sentinex[®] PRO Surgical Gown Special

Wraparound surgical gown based on the Standard version with additional fluid-impermeable reinforcements on the front and sleeve area. Very well suited for surgeries with high amounts of fluid.

Special Plus



Sentinex[®] PRO Surgical Gown Special Plus

Wraparound surgical gown based on the Special version, with the additional feature of a wider reinforcement for safe protection in situations with a lateral fluid burden.

Two packaging options: with sterile wrapping and "direct"

Sentinex[®] PRO Surgical gowns with sterile wrapping

- very well suited for sterile preparation
- with sterile wrapping
- 2 towels



- Ⓐ Sentinex surgical gown
- Ⓑ Towels
- Ⓒ Sterile wrapping
- Ⓓ Sterile packaging

Sentinex[®] PRO Surgical gowns "direct"

- for immediate sterile handover
- for rapid removal
- without sterile wrapping and towels



- Ⓐ Sentinex surgical gown
- Ⓑ Sterile packaging

Sentinex® PRO Surgical Gowns Spunlace

sterile

Size	Length (cm)	REF	Shipping unit (Pieces)
Standard with sterile wrapping, incl. 2 towels			
S / M	120	19 300	44
L	130	19 301	40
XL	150	19 302	36
XL long	170	19 303	32
XXL	150	19 304	32
Special with sterile wrapping, incl. 2 towels			
S / M	120	19 310	40
L	130	19 311	36
XL	150	19 312	32
XL long	170	19 313	28
XXL	150	19 314	28
Set Standard (sterile), 3x XL			
3 x XL	3 x 150	19 308	12
Set Standard (sterile), 2x XL, 1x L			
2 x XL / 1 x L	2 x 150 / 1 x 130	19 309	12
Urology Gown, XL			
XL	150	142 708	40

Sentinex® PRO Surgical Gowns SMMS

sterile

Size	Length (cm)	REF	Shipping units (Pieces)
Standard with sterile wrapping, incl. 2 towels			
S / M	120	19 340	52
L	130	19 341	48
XL	150	19 342	44
XL long	170	19 343	40
XXL	150	19 344	40
Special with sterile wrapping, incl. 2 towels			
S / M	120	19 350	48
L	130	19 351	44
XL	150	19 352	40
XL long	170	19 353	36
XXL	150	19 354	36
Standard "direct" without sterile wrapping			
S / M	120	19 360	52
L	130	19 361	48
XL	150	19 362	44
Special "direct" without sterile wrapping			
S / M	120	19 370	48
L	130	19 371	44
XL	150	19 372	40
Special Plus "direct" without sterile wrapping			
XL	150	31 276	36
Basic "direct" without sterile wrapping			
S / M	120	19 380	48
L	130	19 381	44
XL	150	19 382	40

Sentinex[®] SMART Surgical Gowns



SMART – protection for shorter, less complicated procedures

- focused range of products
- functional design with high user and wearing comfort
- meet the requirements of EN 13795 and the AAMI standard
- designed for
 - ◆ procedures, e.g. operations, with low to medium amounts of fluid
 - ◆ short surgical procedures such as outpatient surgery

Choose the **Standard** or **Special** version depending on the length of the procedure and/or the amount of fluid.



Sentinex SMART Surgical Gown Standard

Wraparound surgical gown with sterile back section thanks to very generous overlap. Optimally suited for procedures with low amounts of fluid.

The material for safety and a comfortable microclimate

- protection against bacteria and fluids in accordance with EN 13795 and the AAMI standard
- air-permeable

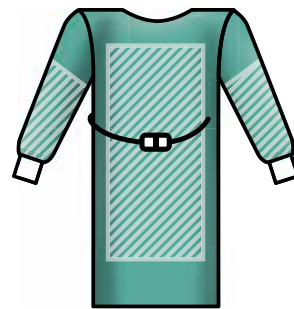

Sentinex SMART Surgical Gown Special

Wraparound surgical gown based on the Standard version with additional fluid-impermeable reinforcements on the front and sleeve area. The reinforcement provides a high level of resistance to soaking and bacterial penetration. Very well suited for surgeries with medium to high amounts of fluid.



Polypropylene

Two packaging options: with sterile wrapping and “direct”

Sentinex SMART Surgical Gowns with sterile wrapping

- very well suited for sterile preparation
- with sterile wrapping
- 2 towels



- A Sentinex SMART Surgical Gowns
- B towels
- C sterile wrapping
- D sterile packaging

Sentinex SMART Surgical Gowns “direct”

- for immediate sterile handover
- for rapid removal
- without sterile wrapping and towels



- A Sentinex SMART Surgical Gowns
- B sterile packaging

Sentinex® SMART Surgical Gowns

sterile

Size	REF	Shipping units (Pieces)
Standard with sterile wrapping, incl. 2 towels		
M / L	33 651	52
XL	33 652	48
XXL	33 653	44
Special with sterile wrapping, incl. 2 towels		
M / L	33 661	48
XL	33 662	44
XXL	33 663	40
Standard “direct” without sterile wrapping		
M / L	109 151	52
XL	109 152	48
XXL	109 153	44
Special “direct” without sterile wrapping		
M / L	109 161	48
XL	109 162	44
XXL	109 163	40

Sentinex® Surgical Face Masks



Sentinex® Lite EL

- comfortable model
- extra lightweight combination of materials for better air permeability
- with ear loops
- efficiency level type II in accordance with EN 14683



Sentinex® Classic

- the premium model
- offers very good wearing comfort thanks to the use of high-quality materials
- efficiency level type II in accordance with EN 14683
- available in blue and green



Sentinex® Classic AntiFog

- the premium model
- with integrated anti-fog strip
- offers very good wearing comfort thanks to the use of high-quality materials
- efficiency level type II in accordance with EN 14683



Sentinex® Sensitive

- natural white mask made from unbleached material
- skin friendly
- with supple and soft inner layer
- contains no artificial colours or bonding agents, an alternative for sensitive skin
- available with and without integrated anti-fog strip
- efficiency level type II in accordance with EN 14683



Sentinex® Sensitive AntiFog



Sentinex® Safety

- a reinforced outer layer prevents penetration of potentially hazardous body fluids for greater protection
- efficiency level type IIR in accordance with EN 14683



Sentinex® SafetyShield

- a reinforced outer layer prevents penetration of potentially hazardous body fluids for greater protection
- fog-free visor protects the entire facial area
- efficiency level type IIR in accordance with EN 14683



Sentinex® ExtraPlus

- the wide cut and horizontally positioned ties increase the size of the breathing chamber
- also suitable for those with short beards
- efficiency level type II in accordance with EN 14683

Sentinex® Surgical Face Masks

Model	REF	Shipping units (Pieces)
Sentinex Lite EL, green, with ear loops	11 992	50/300
Sentinex Classic, green	162 002	50/300
Sentinex Classic, blue	162 003	50/300
Sentinex Classic AntiFog	162 004	50/300
Sentinex Sensitive	162 005	50/300
Sentinex Sensitive AntiFog	162 006	50/300
Sentinex Safety	162 008	50/300
Sentinex SafetyShield	162 009	25/100
Sentinex ExtraPlus	162 010	50/300

Sentinex® Surgical Caps



Sentinex® Soft

- beret-shaped breathable cap
- comfortable to wear with long or short hair



Sentinex® Astro

- safe full-protection helmet-shaped cap
- with seamed edges
- head and neck area are completely covered thanks to the tie closure



Sentinex® Astro Extra

- full-protection helmet-shaped cap
- safe and comfortable
- the integrated soft sweat band absorbs fluid



Sentinex® Fancy

- specifically for long hair
- has a large volume thanks to the central seam
- soft front area has no elasticised rubber band



Sentinex® Flex

- surgeon's cap
- for short hair
- comfortable and very breathable



Sentinex® Easy

- beret-style cap for everyday clinical use
- covers hair completely and reliably
- also suitable for patients and visitors





Sentinex® Nova

- adjustable cap
- front edge can be easily folded back to form a sweat band



Sentinex® Trend

- very comfortable fit
- also suitable for long hair
- elasticised neck area

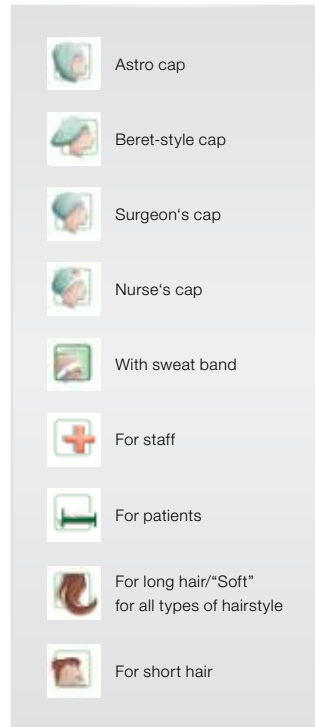

Sentinex® Surgical Caps

Model	REF	Shipping units (Pieces)
Sentinex Soft, beret-style cap, green, breathable	17 420	100/600
Sentinex Astro, astro cap, green	17 421	100/600
Sentinex Astro Extra, astro cap with sweat band, green	17 422	100/600
Sentinex Fancy, nurse's cap with central seam, green	17 423	100/600
Sentinex Nova, nurse's cap with ties, green	17 424	100/600
Sentinex Trend, nurse's cap, long, green	17 425	100/600
Sentinex Flex, surgeon's cap, green	17 426	100/600
Sentinex Easy, green, Beret-style cap	17 427	100/600
Sentinex Easy, blue, Beret-style cap	17 428	100/600
Sentinex Easy, white, Beret-style cap	17 429	100/600

Surgical Gloves made from natural rubber latex



Properties

- easy to don due to the synthetic inner coating
- they have an extra-long shaft specifically for gynaecological procedures

Product composition

- natural rubber latex

Gynaecology Gloves

sterile, sealed in pairs, white, natural rubber latex, powder-free, with a synthetic inner coating

Size	REF	Shipping units (Pair)
6.5 S	19 560	25/100
7.5 M	19 561	25/100
8.5 L	19 562	25/100

Examination Gloves made from natural rubber latex



Fields of application

- for use in hospitals and private medical practices
- for professional cleansing
- suitable for laboratories, pharmaceutical companies and for contact with food

- with synthetic inner coating for quick and easy donning
- high tensile strength
- extra-thin surface

Properties

- have a rolled cuff
- excellent tactile sensitivity and non-slip grip

Product composition

- Natural rubber latex



Sentina® Ambidextrous Latex

non-sterile, in a cardboard dispenser, natural latex, powder-free, with a synthetic inner coating, white

Size	REF	Shipping units
5-6 XS	141 390	100/1000
6-7 S	141 391	100/1000
7-8 M	141 392	100/1000
8-9 L	141 393	100/1000
9-10 XL	141 394	90/900

Examination Gloves made from nitrile



Fields of application

- for use in hospitals and private medical practices
- for professional cleansing
- suitable for laboratories, pharmaceutical companies and for contact with food

- high tensile strength
- free of natural rubber latex
- suitable for users with type I allergies

Product composition

- nitrile-butadiene rubber

Properties

- have a rolled cuff
- excellent tactile sensitivity and high wearing comfort thanks to optimised glove thickness



Sentina® Ambidextrous Nitrile

non-sterile, in a cardboard dispenser, nitrile-butadiene rubber, free of natural rubber latex, powder-free, lavender blue

Size	REF	Shipping units
6-7 S	220 008	200/2000
7-8 M	220 007	200/2000
8-9 L	220 006	200/2000
9-10 XL	220 009	180/1800

Sentina® Azure Nitrile



Fields of application

- for use in hospitals and private medical practices
- for professional cleansing
- suitable for laboratories, pharmaceutical companies and for contact with food

- high tensile strength
- free of natural rubber latex

Product composition

- nitrile-butadiene rubber

Properties

- have a rolled cuff
- excellent tactile sensitivity and textured finger surface



Sentina® Azure Nitrile

non-sterile, in a cardboard dispenser, nitrile-butadiene rubber, free of natural rubber latex, powder-free, blue

Size	REF	Shipping units
5-6 XS	155 360	100/1000
6-7 S	155 361	100/1000
7-8 M	155 362	100/1000
8-9 L	155 363	100/1000
9-10 XL	155 364	100/1000

Cotton Gloves

Cotton gloves



Properties

- Cotton glove made from 100% cotton to cover the hands. Can be worn for example under rubber or latex gloves or when handling sensitive objects.

Product composition

- cotton

Cotton Gloves

non-sterile, made from cotton

Size	REF	Shipping units (Pieces)
7.5	17 574	20/1200
8	17 575	20/1200
8.5	17 576	20/1200
9	17 577	20/1000
9.5	17 578	20/1000
10	17 579	20/1000

Visitor Gowns



Fields of application

- to protect patients from particles and dust on the clothing of visitors and personnel

Product composition

- The Sentina Visitor Gown is made from nonwoven material.

Properties

- use of raw materials that are not made with natural rubber latex
- breathable
- low-linting
- repels fluids

Sentina® Visitor Gowns

made from breathable nonwoven material, green, with white cuffs, a belt and a hook-and-loop fastener at the neck

Length (cm)	REF	Shipping units (Pieces)
non-sterile		
118	18 418	60
sterile		
118	18 419	30

Setpack[®] OR Dressing Materials



Setpack® OR Dressing Materials

Flexible combination of standardised components

The ready-for-use standard set contains laparotomy swabs, gauze swabs, gauze balls or dissecting swabs in appropriate quantities for clinical use.



Counting card system

- dual check system by having each counting card both inside the inner wrapping for sterile materials and in the peel pouch
- makes swab count easier before and after the operation
- no handover of counting cards during the surgical procedure
- clear documentation with self-adhesive counting cards

Inner wrapping for sterile materials

- for gauze swabs and laparotomy swabs
- user-friendly flap for easy-to-open packaging
- the product can be taken out quickly and safely

Sliding box for dissecting swabs

- greater safety thanks to optimal piece count check before and after the surgical procedure
- specially designed for the handy removal of the dissecting swabs



Setpack Toptex lite
Laparotomy Swabs,
X-ray-detectable



Setpack
Gauze Swabs,
X-ray detectable



Setpack
Gauze Balls,
X-ray detectable



Setpack
Dissecting Swabs,
X-ray detectable

Setpack® Toptex® lite Laparotomy Swabs, X-ray-detectable

Field of application

- designed for immediate use in the OR
- intended to be used inside the body, on a surgical incision to control bleeding and absorb fluid
- an X-ray detectable element helps to detect gossypiboma (device left inside the body)

Properties

- made from cotton gauze conform to EN 14079
- prewashed
- absorbent
- 20 threads
- packaged in inner wrapping for sterile materials for a fast and secure removal of the product and a swab count
- separately attached, double, self-adhesive counting cards



Product composition

100% cotton; X-ray detectable chip
(polyvinyl chloride and barium sulphate)

Versions

- white, green and blue
- 4-layered and 6-layered

Setpack® Toptex® lite Laparotomy Swabs, X-ray-detectable

sterile

Contents	Size (cm)	REF	Shipping Unit (Pack)
white			
2 pcs., 4-layered	40 x 40	165 004	20/60
5 pcs., 4-layered	40 x 40	165 001	10/30
2 pcs., 6-layered	40 x 40	165 012	12/36
5 pcs., 6-layered	40 x 40	165 003	6/18
2 pcs., 4-layered	20 x 30	165 011	30/90
5 pcs., 4-layered	20 x 30	165 007	18/54
2 pcs., 4-layered	50 x 60	165 014	12/36
2 pcs., 6-layered	50 x 60	165 019	8/24
2 pcs., 4-layered	8 x 90	165 010	26/104
green			
2 pcs., 4-layered	40 x 40	165 006	20/60
5 pcs., 4-layered	40 x 40	165 002	10/30
2 pcs., 6-layered	40 x 40	165 008	12/36
5 pcs., 6-layered	40 x 40	165 000	6/18
2 pcs., 4-layered	20 x 30	165 017	30/90
5 pcs., 4-layered	20 x 30	165 005	18/54
2 pcs., 4-layered	50 x 60	165 013	12/36
2 pcs., 6-layered	50 x 60	165 018	8/24
2 pcs., 4-layered	8 x 90	165 009	26/104
blue			
2 pcs., 4-layered	40 x 40	15 016	14/42
5 pcs., 4-layered	40 x 40	15 015	6/18

Setpack® Gauze Swabs, X-ray detectable

Field of application

- designed for immediate use in the OR
- intended to be used inside the body, in a surgical incision to control bleeding and absorb fluid
- an X-ray detectable element helps to detect gossypiboma (device left inside the body)

Properties

- made of 100% cotton gauze according to DIN EN 14079, with X-ray thread (blue, polypropylene, polyester thread, barium sulphate)
- absorbent
- all cut edges folded inwards and therefore have no loose threads
- packaged in inner wrapping for sterile materials for a fast and secure removal of the product and a swab count
- separately attached, double, self-adhesive counting cards



Product composition

100% cotton; X-ray detectable thread (blue, polypropylene, polyester thread, barium sulphate)

Versions

- 12-, 16- and 32-ply
- 17 and 20 threads

Setpack® Gauze Swabs, X-ray detectable

sterile

Size (cm)	REF	Shipping unit (Pack)
Pack of 10, 12 ply, 17 threads		
7.5 x 7.5	165 114	22/132
10.0 x 10.0	165 100	20/120
10.0 x 12.5	165 116	20/120
10.0 x 20.0	165 102	16/48
Pack of 10, 16 ply, 17 threads		
5.0 x 5.0	165 110	40/240
7.5 x 7.5	165 106	20/120
10.0 x 10.0	165 101	18/108
10.0 x 12.5	165 111	18/108
Pack of 10, 32 ply, 20 threads		
10.0 x 10.0	165 104	14/42
Pack of 20, 12 ply, 17 threads		
7.5 x 7.5	165 119	14/84
10.0 x 10.0	165 103	10/60
10.0 x 12.5	165 109	10/60
10.0 x 20.0	165 108	8/24
Pack of 20, 16 ply, 17 threads		
5.0 x 5.0	165 117	27/162
7.5 x 7.5	165 118	16/48
10.0 x 10.0	165 105	14/42
10.0 x 12.5	165 112	8/48

Setpack® Gauze Balls, X-ray detectable

Field of application

- designed for immediate use in the OR
- to absorb blood and secretions during surgical procedures

Properties

- made from absorbent cotton gauze in compliance with EN 14079
- soft and highly absorbent
- with silicone safety ring
- 20 threads
- double packaging for sterile materials
- separately attached, double, self-adhesive counting cards

Product composition

100% cotton; X-ray detectable thread (blue, polypropylene, polyester thread, barium sulphate). The safety ring is made from silicone.



Setpack® Gauze Balls, X-ray detectable

sterile

Size	REF	Shipping Unit (Pack)
Packs of 5		
fist-sized 7	22 800	16/48
Packs of 10		
walnut-sized 2	22 801	72/144
plum-sized 3	22 802	38/114
egg-sized 4	22 803	26/78
extra-large 6	22 804	18/54
Packs of 15		
plum-sized 3	22 805	30/90
egg-sized 4	22 806	20/60
extra-large 6	22 807	12/36
Packs of 20		
plum-sized 3	22 808	26/78
egg-sized 4	22 809	16/48
extra-large 6	22 810	6/18

Setpack® Dissecting Swabs, X-ray detectable

Field of application

- designed for immediate use in the OR
- for dissection of organs, blood vessels and tissue layers during surgical procedures

Properties

- made from absorbent cotton gauze in compliance with EN 14079
- firm and highly absorbent
- 24 threads
- in sliding box for swabs for easier swab count and handy removal
- separately attached, double, self-adhesive counting cards

Product composition

100% cotton; X-ray detectable thread (blue, polypropylene, polyester thread, barium sulphate)



Setpack® Dissecting Swabs, X-ray detectable

sterile

Size	REF	Shipping Unit (Pack)
Packs of 10		
small 2	12 780	40/120
medium 3	12 781	40/120
large 4	12 782	40/120
Packs of 20		
small 2	12 783	40/120
medium 3	12 784	40/120
large 4	12 785	40/120

Setpack® OR Dressing Materials

Custom assembled according to your specifications

Setpack Individual offers flexible solutions for all regularly performed surgical procedures. In close cooperation with customers, L&R will analyse the initial situation, define individual requirements, and compile a user-oriented Setpack for your individual needs.

This service is always available for our customers, even if circumstances change. With a standardised packaging system, L&R provides professional expert production of Setpacks for specific customer needs.

The combination of Setpack Standard and Setpack Individual ensures economic use of materials and avoids excessive residual quantities.



Advantages

1. Customisable

- custom assembled in accordance with customer specifications
- individual needs assessment closely coordinated with the customer's specialist departments

2. Economical

- time savings thanks to standardisation of the process workflows
- economic use of materials
- no in-house reprocessing
- no in-house validated sterilisation process required

3. Safe

- repeated piece count checks during Setpack production

Kitpack® OR Custom Procedure Tray



Kitpack® OR Custom Procedure Trays

Kitpack is an efficient OR system comprising various ready-for-use OR components. In addition to including Raucodrape OR drapes, Sentinex Surgical gowns and OR Dressing materials, other components from reputable manufacturers can be integrated on request.

The Kitpack and all its components are compactly packed, sterile, and ready for immediate use.

Sets are custom assembled based on your requirements, depending on the surgical procedures specified.

By using prefabricated Kitpacks, you will reduce preparation times and procedure costs – with full safety and the necessary flexibility.



Raucodrape® OR Drapes

- particularly tear-resistant and absorbent
- safe barrier effect against penetration by fluids and bacteria
- good draping behaviour



Sentinex® Surgical Gowns

- reliable protection against bacteria and fluids
- very high wearing comfort
- skin-friendly and breathable



OR dressing materials

- with X-ray detectable thread or chip
- very absorbent
- with double, self-adhesive counting card

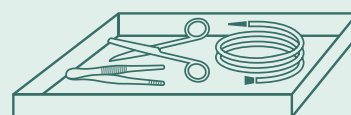

Other single-use surgical components

- such as tubes, suture materials, scalpels, gloves and syringes
- high-quality products
- well-known manufacturers



Added value: Kitpack®

- delivers substantial time savings as there is no need to assemble individual components prior to surgery
- reduces the time spent on logistics and administration because the more straightforward ordering process minimises the work involved in purchasing
- ensures greater safety in the OR because reducing the risk of contamination associated with opening and handover of sterile products improves infection prophylaxis
- makes it easier to document the materials used in the OR because all relevant information is provided on a single label
- increases cost transparency as the costs per case can be allocated faster and more easily than with individual components

Additional safety and time-savings thanks to the colour marking of your Kitpack

Your Kitpack can be provided with a colour marking matching that of your instrument basket. You can choose from 15 different colours and 3 positions where to place the colour points (size: 6 cm in diameter) on the peel pouch.



Kitpack[®] start



Field of application

- Specifically designed for use in the OR

Properties

- immediately available
- no contract terms
- sterile and ready for immediate use
- saves time during surgery preparation and post-processing
- only one ordering step needed for purchasing
- reduces stock-keeping
- flexible during the trial period
- economically pre-assembled

Product composition

Kitpack start contains basic supplies and equipment with the most important ready-for-use single-use components for the specific type of surgery in question.

Versions

- General Surgery Set
- Total Hip Replacement Set
- Extremity Set
- Vascular Split Sheet Set
- C-section Set

General Surgery Set

Contents	Size	REF	Shipping unit
1 Raucodrape OR Table Cover	150 cm x 190 cm	28 145	6
4 Raucodrape Towels	30 cm x 40 cm		
1 Sentinex Surgical Gown SMMS Standard	150 cm		
1 Raucodrape Instrument Table Cover Standard	80 cm x 145 cm		
1 Sentinex Surgical Gown SMMS Standard	150 cm		
1 Sentinex Surgical Gown SMMS Special	150 cm		
1 single-use scalpel, Figure 21 ¹			
1 tray blue ¹	250 ml		
5 Gazin Gauze Balls, X-ray detectable ¹	Size 6 extra-large		
10 Gazin Gauze Balls, X-ray detectable ¹	Size 4 egg-sized		
10 Gazin Dissecting Swabs, X-ray detectable ¹	small, size 2		
10 Gazin Gauze Swabs, X-ray detectable, 16-ply ¹	10 cm x 10 cm		
1 Raucodrape Adhesive Strip, elastic	9 cm x 50 cm		
2 Raucodrape Adhesive Drapes, 2-layered Plus	75 cm x <u>90</u> cm		
1 Raucodrape Adhesive Drape, 2-layered Plus	175 cm x <u>180</u> cm		
1 Raucodrape Adhesive Drape, 2-layered Plus	150 cm x <u>250</u> cm		

¹ Components in folding box

Total Hip Replacement Set

Contents	Size	REF	Shipping unit
1 Raucodrape OR Table Cover	150 cm x 190 cm	28 146	4
4 Raucodrape Towels	30 cm x 40 cm		
1 Sentinex Surgical Gown SMMS Standard	150 cm		
1 Raucodrape Instrument Table Cover Standard	80 cm x 145 cm		
1 Yankauer CH 25 OR suction set ¹	Ø 6 mm		
1 Raucodrape Diathermy Pouch, 1 chamber	38 cm x 40 cm		
2 single-use scalpels, Figure 21 ¹			
1 tray blue ¹	250 ml		
10 Gazin Gauze Balls, X-ray detectable ¹	Size 6 extra-large		
30 Gazin Gauze Swabs, X-ray detectable, 16-ply ¹	10 cm x 10 cm		
2 Toptex lite Laparotomy Swabs, X-ray detectable, green, 6-layered ¹	40 cm x 40 cm		
1 Sentinex Surgical Gown SMMS Standard	150 cm		
2 Sentinex Surgical Gowns SMMS Special	150 cm		
1 Raucodrape OR Adhesive Drape, 2-layered	75 cm x <u>90</u> cm		
1 Raucodrape Orthopaedic Stockinette, incl. 2 adhesive film strips	33 cm x 110 cm 10 cm x 50 cm		
1 Raucodrape OR Drape Sheet, 2-layered	150 cm x 180 cm		
2 Raucodrape Adhesive Strips, elastic	9 cm x 50 cm		
1 Raucodrape Split Sheet, 2-layered Plus, slit	<u>225</u> cm x 260 cm 10 cm x 100 cm		
1 Raucodrape Anaesthesia Drape, 2-layered Plus	225 cm x <u>270</u> cm		

¹ Components in folding box

Extremity Set

Contents	Size	REF	Shipping unit (pack)
1 Raucodrape OR Table Cover	150 cm x 190 cm	28 147	5
2 Raucodrape Towels	30 cm x 40 cm		
1 Sentinex Surgical Gown SMMS Standard	150 cm		
1 Raucodrape Instrument Table Cover Standard	80 cm x 145 cm		
1 Sentinex Surgical Gown SMMS Special	150 cm		
1 Raucodrape Camera Drape, reverse-fold ¹	13 cm x 250 cm		
1 tray blue ¹	250 ml		
3 Curapor Wound Dressings ¹	5 cm x 7 cm		
5 Gazin Gauze Balls, X-ray detectable ¹	Size 6 extra-large		
1 single-use scalpel, Figure 11 ¹			
10 Gazin Gauze Swabs, X-ray detectable, 16-ply ¹	10 cm x 10 cm		
1 Lenkelast All-purpose bandage ¹	12 cm x 5 m		
1 Raucodrape OR Drape Sheet, 2-layered	150 cm x 180 cm		
1 Raucodrape Adhesive Strip, elastic	9 cm x 50 cm		
1 Raucodrape Stockinette, short	24 cm x 80 cm		
1 Raucodrape Extremity Drape, 2-layered Plus	225 cm x 320 cm		

¹ Components in folding box

__ indicates the side with the adhesive area

Vascular Split Sheet Set

Contents	Size	REF	Shipping unit (pack)
1 Raucodrape OR Table Cover	150 cm x 190 cm	28 148	5
4 Raucodrape Towels	30 cm x 40 cm		
1 Sentinex Surgical Gown SMMS Standard	150 cm		
1 Raucodrape Instrument Table Cover Standard	80 cm x 145 cm		
1 Sentinex Surgical Gown SMMS Standard	150 cm		
1 tray blue ¹	250 ml		
1 Curapor Wound Dressing ¹	10 cm x 8 cm		
5 Gazin Gauze Balls, X-ray detectable ¹	Size 6 extra-large		
10 Gazin Dissecting Swabs, X-ray detectable ¹	Size 3, medium		
1 single-use scalpel, Figure 10 ¹			
2 single-use scalpels, Figure 15 ¹			
30 Gazin Gauze Swabs, X-ray detectable, 16-ply ¹	10 cm x 10 cm		
1 Raucodrape Adhesive Strip, elastic	9 cm x 50 cm		
1 Raucodrape Split Sheet, 2-layered Plus, slit	225 cm x 260 cm 10 cm x 100 cm		
1 Raucodrape Adhesive Drape, 2-layered Plus	150 cm x 250 cm		

¹ Components in folding box

C-section Set

Contents	Size	REF	Shipping unit (pack)
1 Raucodrape OR Table Cover	150 cm x 190 cm	28 149	4
4 Raucodrape Towels	30 cm x 40 cm		
1 Sentinex Surgical Gown SMMS Standard	150 cm		
1 Raucodrape Instrument Table Cover Standard	80 cm x 145 cm		
1 Yankauer CH 25 OR suction set ¹	Ø 6 mm		
1 single-use scalpel, Figure 22 ¹			
1 tray blue ¹	250 ml		
20 Gazin Gauze Balls, X-ray detectable ¹	Size 6 extra-large		
10 Gazin Gauze Swabs, X-ray detectable, 16-ply ¹	10 cm x 10 cm		
5 Toptex lite Laparotomy Swabs, X-ray detectable, green, 4-layered ¹	40 cm x 40 cm		
1 Sentinex Surgical Gown SMMS Standard	150 cm		
1 Sentinex Surgical Gown SMMS Special	150 cm		
1 Raucodrape Adhesive Strip, elastic	9 cm x 50 cm		
1 Raucodrape Baby Drape	90 cm x 100 cm		
1 Raucodrape C-section Drape 2 with integrated leggings	260 cm x 310 cm		

¹ Components in folding box

Raucocel® Accessories

Raucocel® Instrument Wipe

Field of application

- for the cleaning of surgical instruments (scalpels)

Properties

- very absorbent
- tear-resistant
- low-lint

Product composition

- polyvinyl alcohol

Raucocel® Headband

Field of application

- used to prevent sweat from dripping from the forehead
- when moistened before wearing, it pleasantly cools as the moisture evaporates
- its high absorbency minimises the need to wipe sweat away

Properties

- very absorbent
- tear-resistant
- low-lint

Product composition

- forehead part: polyvinyl alcohol
- elastic retention band: polyester, polyurethane

Raucocel® Instrument Wipe

sterile

Size (mm)	REF	Shipping unit (pcs.)
76 x 76	10 313	20 / 480

Raucocel® Headband

non-sterile

REF	Shipping unit (pcs.)
11 971	10 / 240



Prevent & Protect
Platform for Infection Control

**Our Platform for
Infection Control**

www.prevent-and-protect.com

L&R OPTILINE®

Your very own hospital solution.

To ensure continued success in the growing health care market in the future, it is essential to already be well-prepared today. Increasing quality competition, cost and time pressure, a shortage of skilled workers and outpatient care – the challenges in routine clinical practice are many and varied.

We help you to standardise your processes, combine sophisticated patient care with essential economic efficiency, link the aims of administration with those of the users and optimise your outpatient units so that you have more time to care for your patients. Here is a selection of our solution methods that we use to make this possible for you.

In our work, we focus on three main topics:

⊕ Efficiency

You generate potential savings by optimising processes and products.

⊕ Expertise

You benefit from personal support from experienced specialists.

⊕ Partnership

You profit from a strategic partnership on an equal footing.

All-round support with L&R OPTILINE® – our modules and services at a glance:

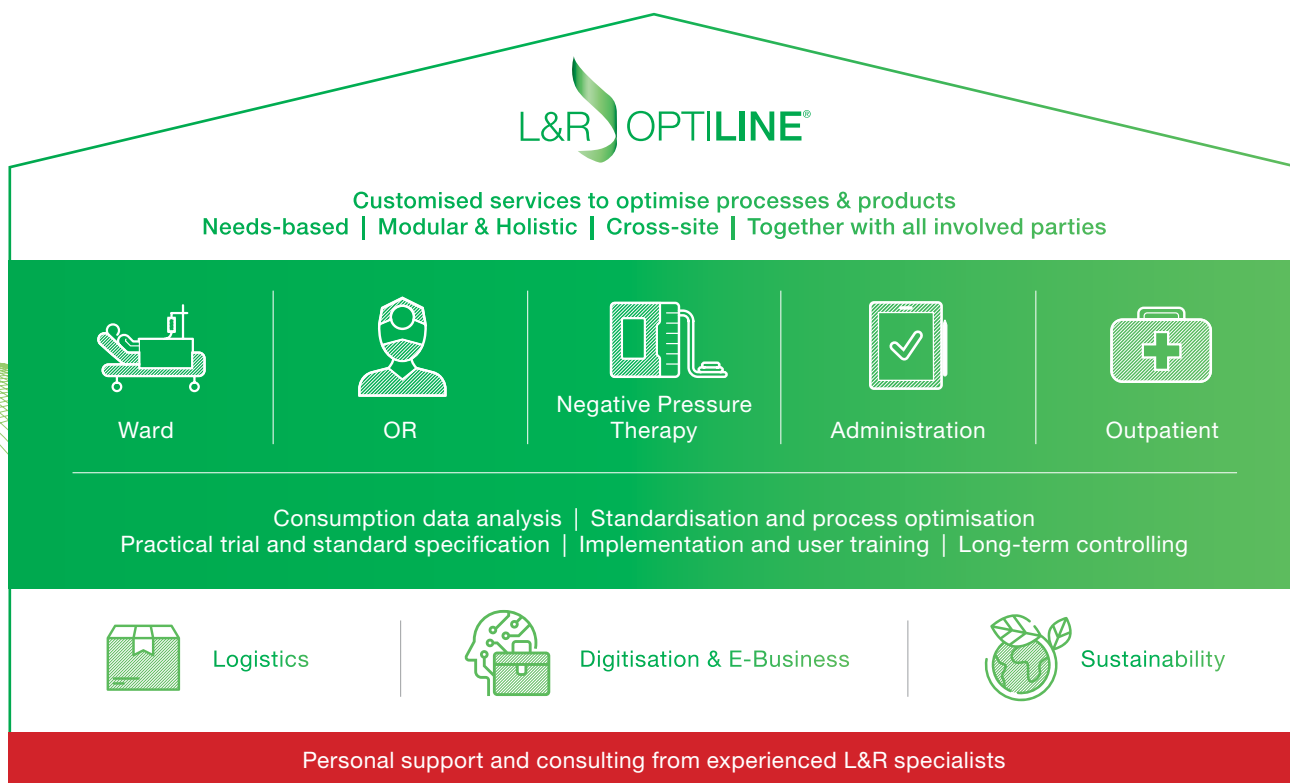



Your added value:

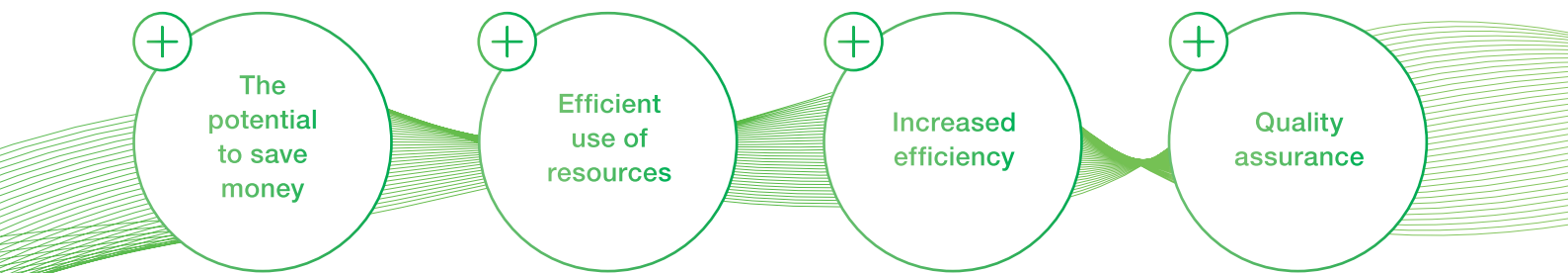

Get to know L&R OPTILINE®

Arrange an individual consultation and together, we will find out how you can benefit from the first-class quality of our services and products.

→ info@de.LRmed.com

→ www.Lohmann-Rauscher.com





People.Health.Care.